

INTERKA PANAREA

POLYWARM® CALORIFIER WITH DOUBLE WALL EXCHANGER
SPECIFIC FOR THERMOSYPHON SOLAR THERMAL SYSTEMS



APPLICATION

Production and storage of domestic hot water (DHW).

MATERIAL

Mild steel Polywarm® coated (Attestation ACS - SSICA - EN 16421 - WRAS).

HEAT EXCHANGER:

Double wall heat exchanger.

INSULATION

High thermal insulation with ecological polyurethane hard foam.

External coating in metal sheet protected by a particular anticorrosive treatment.

CATHODE PROTECTION

Magnesium anode.

WARRANTY

5 years (See general sales conditions and warranty)

ACCESSORIES AND SPARE PARTS

See Accessories section for the entire list.



POLYWARM®
COATED
DHW STORAGE



PROMPT
AVAILABILITY



INTERKA PANAREA WB

Model	HARD FOAM INSULATION Art. Nr.	DOUBLE WALL EXCHANGER		ENERGY EFFICIENCY CLASS 
		Surface [m²]	Volume [lt]	
150	3068160980166	0,80	8,0	B
200	3068160980167	1,20	12,0	B
300	3068160980168	2,05	21,0	B

ACCESSORIES

Electric immersion heater with cover

Art. Nr.	Output	Connection	
5240000000073	1,5 kW	1" 1/4	

SEE CORDIVARI INTEGRATED THERMAL SOLAR SYSTEMS CATALOGUE

HEAT MANAGER

See CORDIVARI INTEGRATED THERMAL SOLAR SYSTEMS catalogue



Magnesium anode

ART. NR.	Model	
5200000041008	150	
5200000041009	200,300	
2 units box		

INTERKA PANAREA

POLYWARM® CALORIFIER WITH DOUBLE WALL EXCHANGER
SPECIFIC FOR THERMOSYPHON SOLAR THERMAL SYSTEMS

STORAGE		HEAT EXCHANGER	
Pmax	Tmax	Pmax	Tmax
6 bar	90 °C	2,5 bar	99 °C

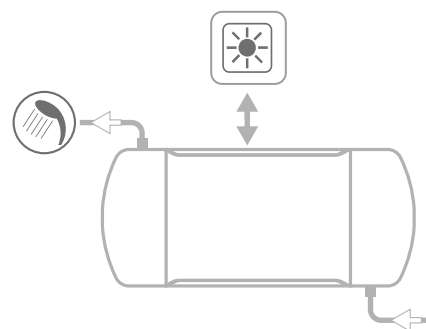

- A** Domestic hot water outlet 3/4" G F

- B** Connection for magnesium anode

- C** Solar collector connection 3/4" G F

- D** Solar collector connection 3/4" G F

- E** Domestic water inlet 3/4" G F

- F** Overflow volume 1/2" G F

- G** Instrumentation 1/2" G F

- H** Electric immersion heater 1" 1/4 G F (optional)

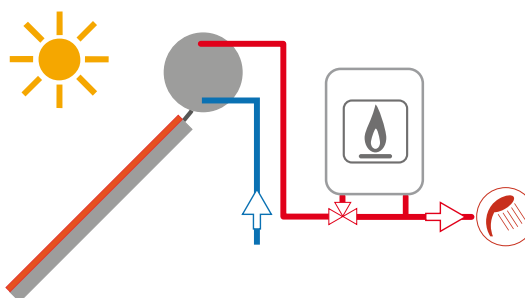
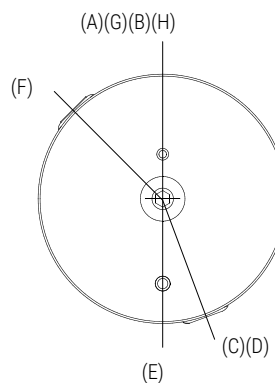
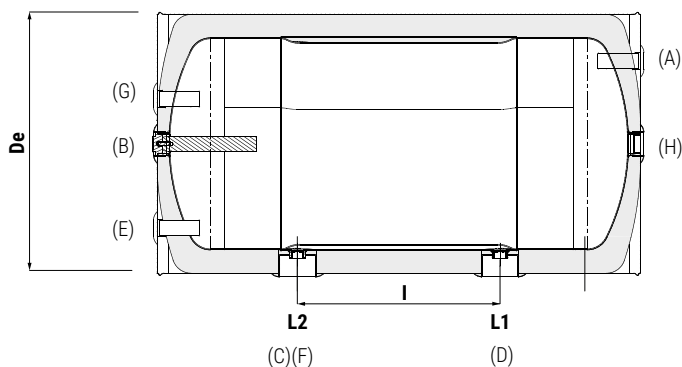

Model	Volume [lt]	De	L	l [mm]	L1	L2
150	143	550	1026	430	298	728
200	183	550	1286	640	323	963
300	270	550	1840	1090	375	1465

P.E.D. product designed and produced in conformity to the article 4.3 of directive 2014/68/UE - ErP Ecodesign directive 2009/125/CE