

# BOLLY® 2 ST INOX

STAINLESS STEEL 316L DOMESTIC HOT WATER CALORIFIER  
WITH 2 FIXED STAINLESS STEEL HEAT EXCHANGERS



## APPLICATION

Production and storage of domestic hot water (DHW).  
All the connections are aligned on the front and on the back for quick and easy installation.

## MATERIAL

Stainless Steel 316 L suitable for domestic hot water

## HEAT EXCHANGER:

N° 2 fixed stainless steel 316L heat exchangers.

## INSULATION

- HARD: High thermal insulation with ecological polyurethane hard foam.
- SOFT: NOFIRE® polyester fleece 100% made of recyclable material, with high thermal insulation. Fire resistance class B-s2d0 according to EN 13501. Grey PVC external lining.

## CATHODE PROTECTION

Magnesium anode - Models > 800 n° 2 magnesium anodes.

## DRAIN

External confluence through drain connection

## GASKET- FLANGE PLATE

Silicone gaskets suitable for water intended for human consumption (tested according to 98/83/CE); Stainless steel blind flange.

## WARRANTY

5 years (See general sales conditions and warranty)

## ACCESSORIES AND SPARE PARTS

See Accessories section for the entire list.

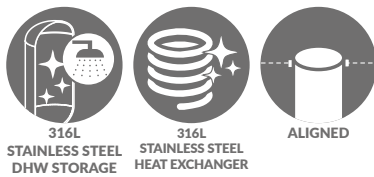

316L STAINLESS STEEL DHW STORAGE  
316L STAINLESS STEEL HEAT EXCHANGER  
ALIGNED



## BOLLY® 2 ST XB

Model	HARD FOAM INSULATION Art. Nr.	316L STAINLESS STEEL HEAT EXCHANGERS SURFACE		ENERGY EFFICIENCY CLASS ErP
		Upper	Lower	
<b>150</b>	3134052010200	0,4	0,6	<b>B</b>
<b>200</b>	3134052010201	0,5	0,7	<b>B</b>
<b>300</b>	3134052010202	0,7	1	<b>B</b>
<b>400</b>	3134052010203	1,1	1,4	<b>C</b>
<b>500</b>	3134052010204	1,2	1,7	<b>C</b>



## BOLLY® 2 ST XC

Model	DISMOUNTABLE SOFT FLEECE INSULATION Art. Nr.	316L STAINLESS STEEL HEAT EXCHANGERS SURFACE		ENERGY EFFICIENCY CLASS ErP
		Upper	Lower	
<b>800</b>	3138052010200	1,6	2,4	<b>C</b>
<b>1000</b>	3138052010201	1,7	2,9	<b>C</b>
<b>1500</b>	3138052010202	2,1	3,6	<b>C</b>
<b>2000</b>	3138052010203	2,3	3,8	<b>C</b>

## ACCESSORIES

### ELECTRIC IMMERSION HEATERS

Mod.	Heated volume by electric immersion heater [lt]	MONOPHASE		
		1,5 kW	2 kW	3 kW
		5240000000051	5240000000052	5240000000053
		Ignition time from 10 °C to 45 °C with electric immersion heaters [min]		
<b>150</b>	55	98	73	49
<b>200</b>	65	117	88	59
<b>300</b>	113	203	152	101
<b>400</b>	171	307	230	154
<b>500</b>	188	337	253	168
<b>800</b>	279	500	375	250
<b>1000</b>	381	682	511	341
<b>1500</b>	640	1147	860	573
<b>2000</b>	919	1646	1235	823

THREEPHASE				
4 kW	5 kW	6 kW	9 kW	12 kW
5240000000047	5240000000048	5240000000049	5240000000050	5240000000031
Ignition time from 10 °C to 45 °C with electric immersion heaters [min]				
37	//	//	//	//
44	//	//	//	//
76	61	//	//	//
115	92	//	//	//
126	101	84	//	//
188	150	125	83	63
256	205	170	114	85
430	344	287	191	143
617	494	412	274	206

### HEAT MANAGER + electric immersion heater 1,5 kW + probe +3m cable

Art. Nr.	ELECTRIC IMMERSION HEATER
5240000000074	1,5 kW
5240000000075	2 kW
5240000000076	3 kW

### Thermometer

Art. Nr.
5032240000107
5 units box

# BOLLY® 2 ST INOX

STAINLESS STEEL 316L DOMESTIC HOT WATER CALORIFIER  
WITH 2 FIXED STAINLESS STEEL HEAT EXCHANGERS

STORAGE		HEAT EXCHANGER	
Pmax	Tmax	Pmax	Tmax
6 bar	95 °C	12 bar	110 °C

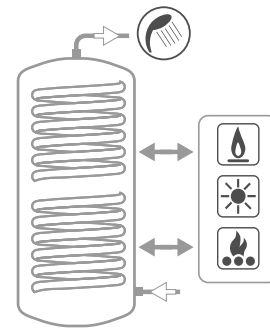

- A** Domestic hot water outlet
- B** Recirculation
- C** Connection for instrumentation 1/2" G F
- D** Connection for electric immersion heater
- E** Connection for magnesium anode 1"1/4 G F
- F** Lower heat exchanger inlet 1" G F
- G** Lower heat exchanger outlet 1" G F
- J** Connection for 2nd magnesium anode 1"1/4 G F (Models > 800)
- K** Flange for inspection
- M** Domestic cold water circuit inlet
- L** Upper heat exchanger outlet 1"1/4 G F
- I** Upper heat exchanger inlet 1"1/4 G F
- O** Drain

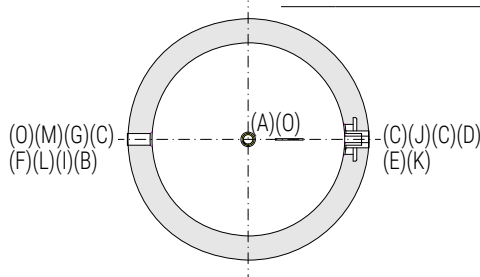
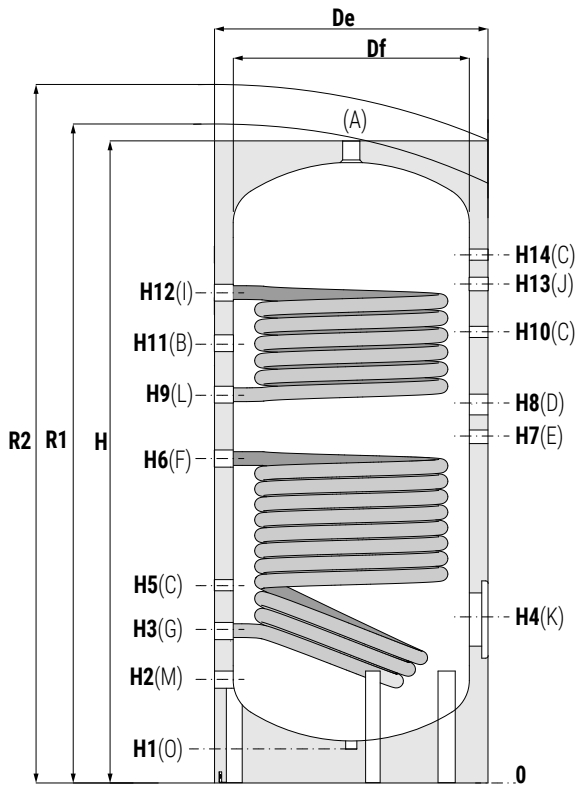

## BOLLY® 2 ST INOX - HARD FOAM INSULATION (XB)

Model	Volume [lt]	Weight [kg]	Df	De	H	R2	H1	H2	H3	H4	H5	H6	H7	H8	H9	H10	H11	H12	H14
<b>150</b>	150	35	400	500	1420	1510	65	200	310	340	480	718	750	890	935	1030	1060	1180	1180
<b>200</b>	192	43	450	550	1440	1540	65	210	320	310	430	788	810	930	962	1070	1094	1200	1200
<b>300</b>	293	69	550	650	1495	1638	70	240	350	380	460	755	780	910	957	1050	1110	1230	1230
<b>400</b>	425	85	600	700	1770	1907	65	250	360	390	470	895	925	1050	1082	1190	1325	1469	1480
<b>500</b>	503	99	650	750	1796	1950	65	260	370	400	480	923	970	1105	1155	1268	1335	1479	1490

Model	A	B	C	D	E	Connections F							K
						F	G	M	O	L	I	[mm]	
<b>150</b>	1"	3/4"	1/2"	1"1/2"	1"1/4"	1"	1"	3/4"	1/2"	1"	1"	Øi120/Øe180	
<b>200</b>	1"	3/4"	1/2"	1"1/2"	1"1/4"	1"	1"	3/4"	1/2"	1"	1"	Øi120/Øe180	
<b>300</b>	1"	1"	1/2"	1"1/2"	1"1/4"	1"	1"	1"	1/2"	1"	1"	Øi120/Øe180	
<b>400</b>	1"	1"	1/2"	1"1/2"	1"1/4"	1"	1"	1"	1/2"	1"	1"	Øi120/Øe180	
<b>500</b>	1"	1"	1/2"	1"1/2"	1"1/4"	1"	1"	1"	1/2"	1"	1"	Øi120/Øe180	

## BOLLY® 2 ST INOX - DISMOUNTABLE SOFT FLEECE INSULATION (XC)

Model	Volume [lt]	Weight [kg]	Df	De	H	R1	R2	H1	H2	H3	H4	H5	H6	H7	H8	H9	H10	H11	H12	H13	H14
<b>800</b>	759	156	790	990	1943	1968	2185	114	323	443	473	563	998	1033	1193	1413	1339	1413	1563	//	1563
<b>1000</b>	902	193	790	990	2193	2231	2415	114	318	443	473	563	996	1043	1233	1333	1412	1493	1633	1683	1813
<b>1500</b>	1398	271	1000	1240	2197	2260	2530	114	327	462	492	582	1012	1042	1182	1217	1381	1432	1637	1652	1782
<b>2000</b>	2018	381	1250	1470	2070	2204	2555	85	350	485	515	605	939	965	1105	1155	1258	1305	1455	1485	1605

Model	A	B	C	D	E	Connections F							K	M	O	L	I
						F	G	J	K	[mm]							
<b>800</b>	1"1/4"	1"	1/2"	1"1/2"	1"1/4"	1"1/4"	1"1/4"	//	Øi120/Øe180	1"	3/4"	1"1/4"	1"1/4"				
<b>1000</b>	1"1/4"	1"	1/2"	2"	1"1/4"	1"1/4"	1"1/4"	1"1/4"	Øi120/Øe180	1"	3/4"	1"1/4"	1"1/4"				
<b>1500</b>	2"	2"	1/2"	2"	1"1/4"	1"1/4"	1"1/4"	1"1/4"	Øi170/Øe240	2"	1"	1"1/4"	1"1/4"				
<b>2000</b>	2"	2"	1/2"	2"	1"1/4"	1"1/4"	1"1/4"	1"1/4"	Øi170/Øe240	2"	1"	1"1/4"	1"1/4"				

P.E.D. product designed and produced in conformity to the article 4.3 of directive 2014/68/UE - ErP Ecodesign directive 2009/125/CE

# BOLLY® 2 ST INOX

## HEAT EXCHANGERS TECHNICAL DATA



Data have been calculated on following basis:

- 1) Primary circuit at T1 and proper energy source;
- 2) Production of DHW in continuous from 10 °C to t2;
- 3) DHW that can be taken in the first 10' and in the first hour from storage at t2, input 10 °C and output 45 °C;
- 4) Non-scaling sanitary water

UPPER  
HEAT EXCHANGER

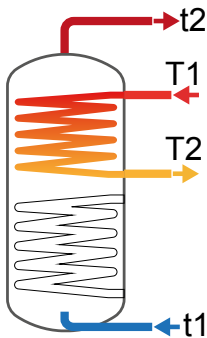

Model	Primary flow rate [m³/h]	Ignition time (minutes) from 10 °C to t2 and primary at T1				Maximum power exchange (kW) with primary at T1, secondary within 10-45 °C and constant use of DHW production				DHW continuous production lt/h within 10-45 °C and primary at T1			
		T1/t2				T1				T1			
		55/50	65/60	70/60	80/60	55	65	70	80	55	65	70	80
150	2	57	62	38	24	3,3	4,2	5,4	7,6	66	67	87	126
	1	65	70	43	27	3,1	3,9	5,0	7,0	61	62	81	116
200	2,5	47	49	32	21	4,9	6,2	7,9	11,2	100	101	132	189
	1,25	52	55	36	23	4,6	5,8	7,4	10,4	94	95	123	175
300	3	50	52	35	23	6,8	8,5	10,9	15,4	140	142	185	263
	1,5	55	58	39	25	6,4	8,1	10,3	14,4	133	135	173	245
400	3,5	57	59	41	26	10,2	12,8	16,4	23,1	214	217	280	397
	1,75	63	66	45	29	9,6	12,2	15,5	21,5	203	206	264	369
500	3,5	54	56	39	25	11,2	14,1	18,1	25,4	237	240	310	438
	1,75	60	63	43	28	10,6	13,4	17,0	23,6	224	228	291	406
800	6	60	62	43	28	15,0	18,9	24,2	34,0	320	324	416	588
	3	65	68	48	31	14,3	18,0	22,9	31,8	305	309	394	550
1000	6	49	51	36	23	15,7	19,7	25,2	35,4	334	338	435	613
	3	54	57	40	26	14,9	18,8	23,9	33,1	318	322	411	573
1500	6	82	85	60	39	19,6	24,7	31,6	44,2	421	425	545	766
	3	91	95	67	44	18,6	23,5	29,7	41,1	399	404	513	711
2000	6	98	101	71	47	21,5	27,0	34,5	48,2	460	466	596	836
	3	109	114	80	53	20,3	25,7	32,4	44,7	436	442	560	775

Model	Primary flow rate [m³/h]	DHW produced in the first 10 minutes in lt/10' input 10 °C output 45 °C, storage at t2 and primary at T1				DHW produced in the first hour in lt/60' input 10 °C output 45 °C, storage at t2 and primary at T1				Heat exchanger pressure drop	
		T1/t2				T1/t2				[mmH <sub>2</sub> O]	[mbar]
		55/50	65/60	70/60	80/60	55/50	65/60	70/60	80/60		
150	2	62	75	79	85	104	105	121	152	146	14
	1	62	75	78	84	100	101	116	144	42	4
200	2,5	83	100	105	114	146	147	172	217	295	29
	1,25	82	99	103	112	141	142	165	206	85	8
300	3	124	149	157	170	213	214	249	311	533	52
	1,5	123	148	155	167	207	209	239	297	155	15
400	3,5	211	255	265	285	346	348	399	492	1002	98
	1,75	209	253	263	280	337	340	386	470	293	29
500	3,5	224	270	282	303	374	376	432	534	1096	107
	1,75	221	268	279	298	363	366	417	509	321	31
800	6	331	401	416	445	534	537	611	748	749	73
	3	329	399	413	439	522	525	593	718	218	21
1000	6	296	356	373	402	507	510	588	730	777	76
	3	293	354	369	396	494	498	569	698	227	22
1500	6	566	691	711	748	833	836	932	1109	954	94
	3	563	687	706	739	815	819	906	1065	279	27
2000	6	722	885	906	946	1014	1019	1123	1315	1036	102
	3	718	881	900	936	995	999	1094	1266	304	30

# BOLLY® 2 ST INOX

## HEAT EXCHANGERS TECHNICAL DATA



Data have been calculated on following basis:

- 1) Primary circuit at T1 and proper energy source;
- 2) Production of DHW in continuous from 10 °C to t2;
- 3) DHW that can be taken in the first 10' and in the first hour from storage at t2, input 10 °C and output 45 °C;
- 4) Non-scaling sanitary water

LOWER  
HEAT EXCHANGER

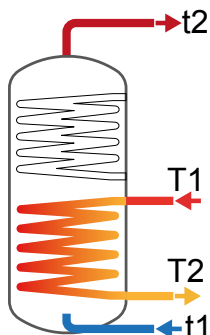

Model	Primary flow rate [m³/h]	Ignition time (minutes) from 10 °C to t2 and primary at T1				Maximum power exchange (kW) with primary at T1, secondary within 10-45 °C and constant use of DHW production				DHW continuous production lt/h within 10-45 °C and primary at T1			
		T1/t2				T1				T1			
		55/50	65/60	70/60	80/60	55	65	70	80	55	65	70	80
150	2	112	118	79	50	5,3	6,6	8,5	12,0	108	110	142	203
	1	128	135	89	57	4,9	6,2	7,9	11,0	100	102	131	185
200	2,5	111	116	79	51	6,7	8,4	10,8	15,2	139	141	182	259
	1,25	124	131	88	57	6,3	7,9	10,1	14,0	130	132	169	238
300	3	108	112	78	50	10,3	13,0	16,7	23,4	218	221	285	403
	1,5	121	127	87	57	9,7	12,3	15,6	21,6	206	209	266	371
400	3,5	115	120	83	55	13,9	17,6	22,5	31,5	297	301	386	544
	1,75	130	136	95	62	13,2	16,6	21,0	29,0	280	284	361	501
500	3,5	118	123	86	56	16,2	20,4	26,0	36,4	345	350	449	630
	1,75	135	141	99	65	15,2	19,3	24,3	33,4	325	330	418	577
800	6	121	126	89	58	23,3	29,3	37,4	52,2	500	506	647	906
	3	136	142	100	66	22,0	27,8	35,1	48,3	473	480	607	837
1000	6	127	132	93	61	26,6	33,4	42,6	59,3	571	578	738	1031
	3	144	150	106	70	25,1	31,7	39,8	54,6	539	547	690	948
1500	6	163	169	120	79	32,6	41,1	52,1	72,4	703	711	905	1259
	3	187	195	139	92	30,7	38,7	48,5	66,1	660	671	842	1149
2000	6	220	229	162	107	35,0	44,1	56,0	77,5	755	765	972	1349
	3	254	265	189	126	32,9	41,6	52,0	70,6	709	720	902	1228

Model	Primary flow rate [m³/h]	DHW produced in the first 10 minutes in lt/10' input 10 °C output 45 °C, storage at t2 and primary at T1				DHW produced in the first hour in lt/60' input 10 °C output 45 °C, storage at t2 and primary at T1				Heat exchanger pressure drop	
		T1/t2				T1/t2				[mmH <sub>2</sub> O]	[mbar]
		55/50	65/60	70/60	80/60	55/50	65/60	70/60	80/60		
150	2	188	231	237	247	257	258	284	333	213	21
	1	187	230	235	244	250	252	275	318	62	6
200	2,5	241	296	303	316	329	331	364	425	413	40
	1,25	240	295	301	313	322	324	353	409	120	12
300	3	371	455	466	486	509	512	563	657	782	77
	1,5	369	453	463	480	500	502	548	632	229	23
400	3,5	535	657	671	698	723	727	795	921	1345	132
	1,75	532	654	667	691	710	713	775	887	395	39
500	3,5	632	777	793	824	851	855	934	1079	1551	152
	1,75	629	774	788	815	835	839	909	1036	456	45
800	6	951	1169	1192	1235	1267	1272	1385	1592	1118	110
	3	946	1164	1185	1224	1246	1251	1353	1537	328	32
1000	6	1126	1385	1412	1460	1488	1493	1621	1856	1266	124
	3	1121	1380	1404	1447	1462	1468	1583	1789	375	36
1500	6	1715	2116	2148	2207	2160	2167	2322	2605	1542	151
	3	1708	2109	2137	2189	2126	2135	2271	2517	454	45
2000	6	2432	3010	3045	3108	2910	2918	3084	3385	1653	162
	3	2424	3003	3033	3088	2873	2882	3028	3289	487	48

# BOLLY® 2 ST INOX

## UPPER HEAT EXCHANGERS PRESSURE DROP

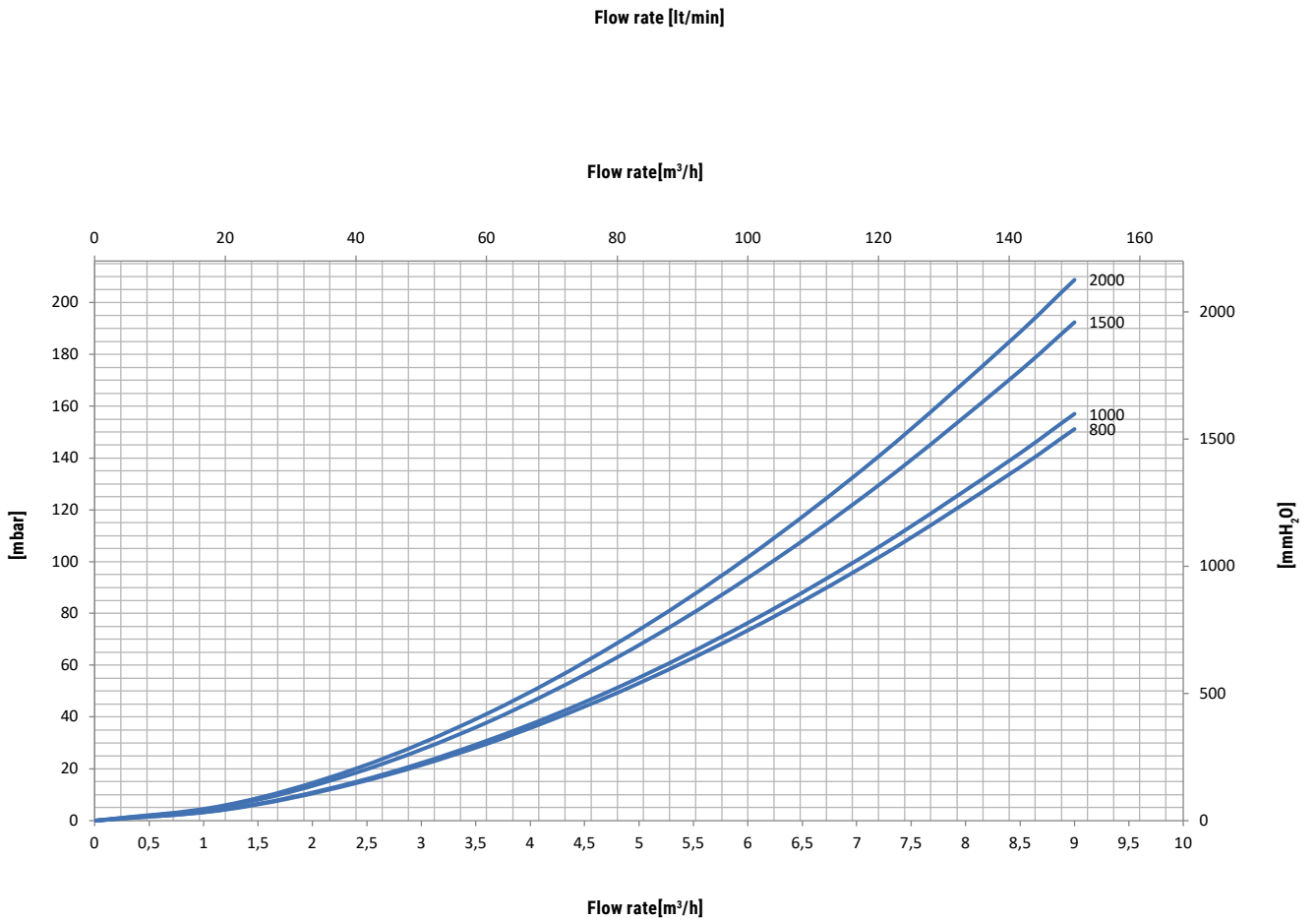
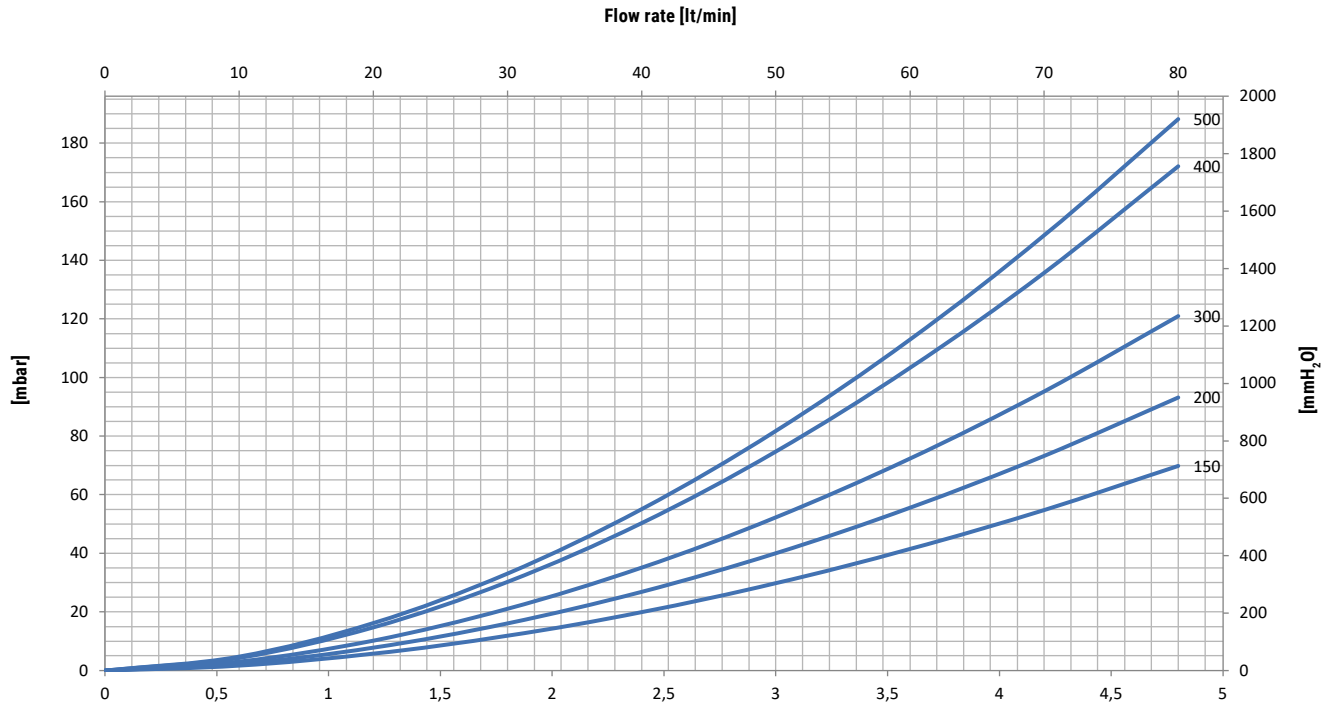

PLEASE NOTE: FOR HEAT EXCHANGERS PRESSURE DROP SEE BOLLY® 1 ST

# BOLLY® 2 ST INOX

## UPPER HEAT EXCHANGERS TECHNICAL DATA



Heat Exchanger output referred to temperature and flow rate of primary circuit and with secondary at 10/45°C at maximum withdrawal of producible DHW (Upper limit of the curves referred to maximum primary flow rate in the heat exchanger, while the lower limit in the curves refer to the minimum primary flow rate).  
For Lower upper heat exchangers technical data- see BOLLY® 1 ST

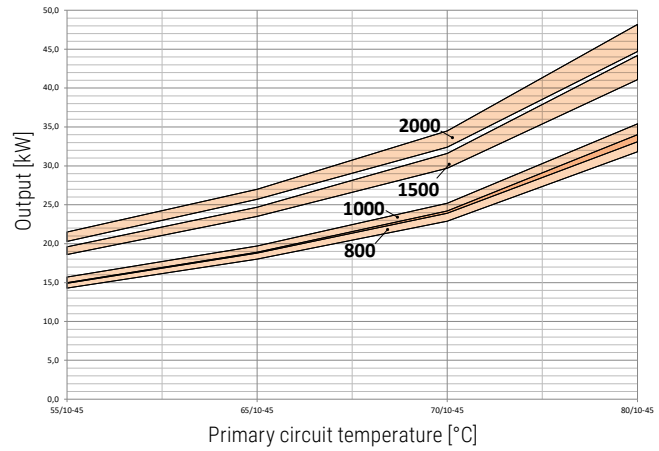
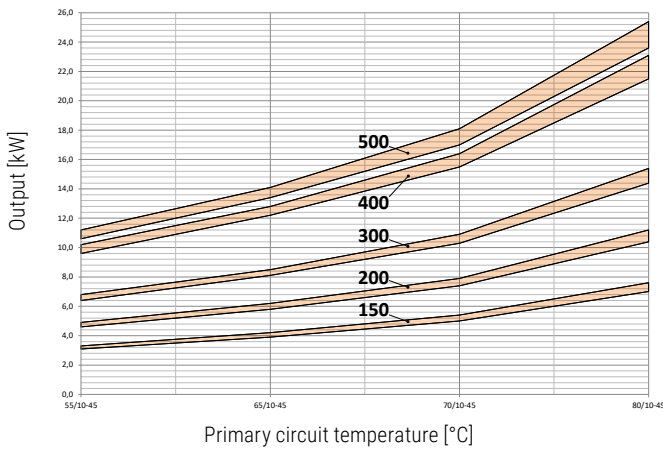

Model Bolly® 2 ST inox	150		200		300		400		500	
Flow rate [m³/h]	MAX	MIN	MAX	MIN	MAX	MIN	MAX	MIN	MAX	MIN
	2	1	2,5	1,25	3	1,5	3,5	1,75	3,5	1,75

Model Bolly® 2 ST inox	800		1000		1500		2000	
Flow rate [m³/h]	MAX	MIN	MAX	MIN	MAX	MIN	MAX	MIN
	6	3	6	3	6	3	6	3

### EXAMPLE OF INSTALLATION WITH BOLLY® 2 ST INOX

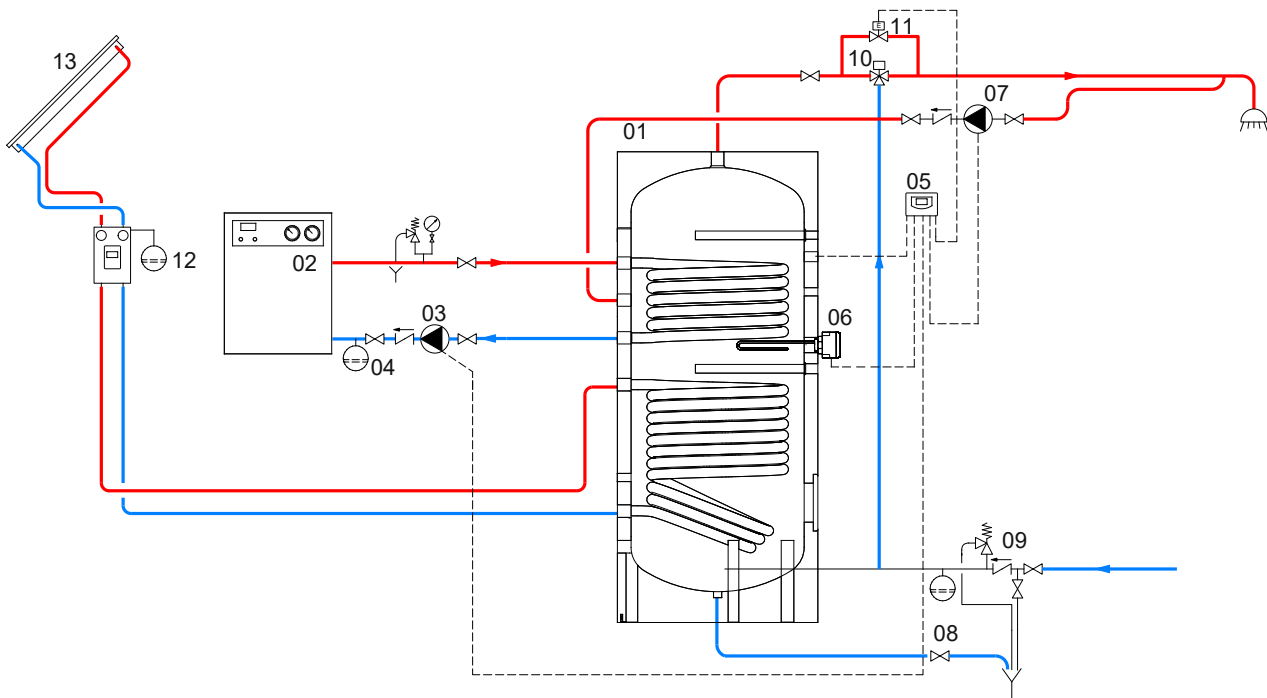

1	BOLLY® 2 ST INOX	5	Electronic Control/thermostat	9	Hydraulic safety group	13	Solar panels
2	Generator	6	Electric immersion heater (optional)	10	Thermostatic mixing valve		
3	Circulation group	7	D.H.W. recirculation group	11	By-pass solenoid valve		
4	Expansion vessel	8	Blowdown valve	12	Solar system circulation group		

The following schemes are purely illustrative. To realize the installation, always refer to a qualified technician.