

BOLLY® 2 ST FB - WITH ALIGNED FRONT / BACK CONNECTIONS

POLYWARM® COATED DOMESTIC HOT WATER CALORIFIER WITH 2 FIXED HEAT EXCHANGERS



APPLICATION

Production and storage of domestic hot water (DHW). All the connections are aligned on the front and on the back for quick and easy installation.

MATERIAL

Mild steel Polywarm® coated (Attestation ACS - SSICA - EN 16421 - WRAS).

HEAT EXCHANGER

2 Mild steel Polywarm® coated heat exchangers

INSULATION

HARD: High thermal insulation with ecological polyurethane hard foam. SOFT: NOFIRE® polyester fleece 100% made of recyclable material, with high thermal insulation. Fire resistance class B-s2d0 according to EN 13501. Grey PVC external lining.

CATHODE PROTECTION

Magnesium anode.

DRAIN

External confluence through drain connection. Models > 500 external confluence through drain connection.

GASKET- FLANGE PLATE

Silicone gaskets suitable for water intended for human consumption (tested according to 98/83/CE), max temperature up to 200°C. Mild steel inspection flange plate Polywarm® coated.

WARRANTY

5 years (See general sales conditions and warranty)

ACCESSORIES AND SPARE PARTS

See Accessories section for the entire list.

NEW



POLYWARM® COATED DHW STORAGE



POLYWARM® COATED HEAT EXCHANGER

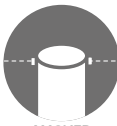

ALIGNED



BOLLY® 2 ST FB WB

HEAT EXCHANGER SURFACE

ENERGY EFFICIENCY CLASS

Model	HARD FOAM INSULATION Art. Nr.	HEAT EXCHANGER SURFACE [m ²]		ENERGY EFFICIENCY CLASS
		Upper	Lower	
150	3134162330011	0,4	0,6	B
200	3134162330012	0,5	0,8	B
300	3134162330013	0,7	1,2	B
400	3134162330014	1	1,5	C
500	3134162330015	1	1,8	C
800	3134162330016	1,6	2,7	B
1000	3134162330017	1,8	3,5	B
1500	3134162330018	1,9	3,8	C



BOLLY® 2 ST FB WC

HEAT EXCHANGER SURFACE

ENERGY EFFICIENCY CLASS

Model	DISMOUNTABLE SOFT FLEECE INSULATION Art. Nr.	HEAT EXCHANGER SURFACE [m ²]		ENERGY EFFICIENCY CLASS
		Upper	Lower	
800	3138162320112	1,6	2,7	C
1000	3138162320113	1,8	3,5	C
1500	3138162320114	1,9	3,8	C

ACCESSORIES

ELECTRIC IMMERSION HEATERS

Mod.	MONOPHASE		
	1,5 kW	2 kW	3 kW
	5240000000051	5240000000052	5240000000053
	Ignition time from 10 °C to 45 °C with electric immersion heaters [min]		
150	54	97	73
200	67	120	90
300	106	190	143
400	159	285	213
500	174	312	234
800	310	554	416
1000	390	698	524
1500	559	1002	751

Mod.	THREEPHASE				
	4 kW	5 kW	6 kW	9 kW	12 kW
	5240000000047	5240000000048	5240000000049	5240000000050	5240000000031
	Ignition time from 10 °C to 45 °C with electric immersion heaters [min]				
	37	//	//	//	//
	45	//	//	//	//
	71	57	//	//	//
	107	85	//	//	//
	117	93	78	//	//
	208	166	139	92	69
	262	210	175	116	87
	376	301	250	167	125

Electric immersion heaters



See Accessories section

Flange plate for electric immersion heater

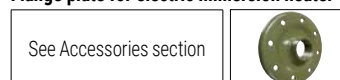

See Accessories section

Titanium anode



See Accessories section

BOLLY® 2 ST FB - WITH ALIGNED FRONT / BACK CONNECTIONS

POLYWARM® COATED DOMESTIC HOT WATER CALORIFIER WITH 2 FIXED HEAT EXCHANGERS

Model	STORAGE		HEAT EXCHANGER	
	Pmax	Tmax	Pmax	Tmax
150 ÷ 800	10 bar	90 °C	12 bar	110 °C
1000 ÷ 1500	8 bar			

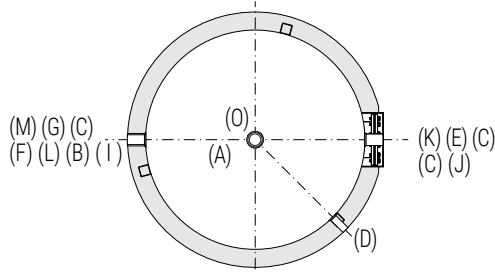
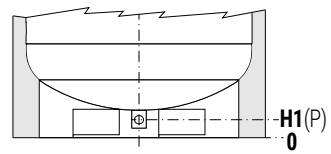
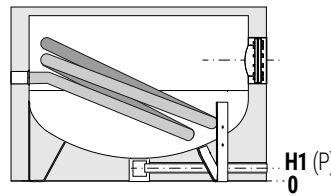
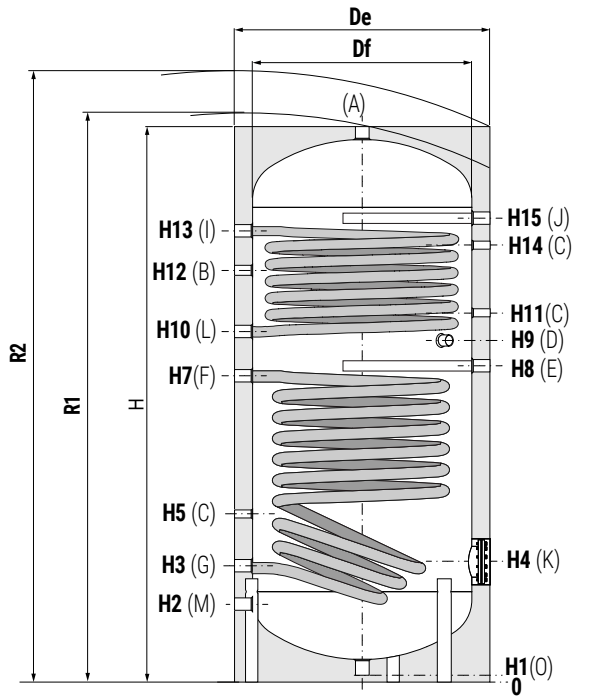
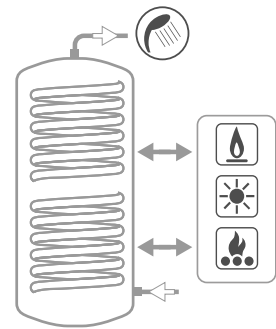

A	Domestic hot water outlet
B	Recirculation
C	Connection for instrumentation 1/2" G F
D	Connection for electric immersion heater
E	Connection for magnesium anode 1 1/4" G F
F	Lower heat exchanger inlet 1 1/4" G F
G	Lower heat exchanger outlet 1 1/4" G F
I	Upper heat exchanger inlet 1 1/4" G F
J	Connection for 2nd magnesium anode 1 1/4" G F (only for models >500)
K	Flange for inspection
L	Upper heat exchanger outlet 1 1/4" G F
M	Domestic cold water circuit inlet
O	Drain 1 1/4" F For models ≤ 500
P	Drain For models > 500

Models 1500 are equipped with a practical **skirt** support which facilitate the handling with transpallets and forklifts. Also, discharge piping already mounted to allow **total emptying**.

BOLLY® 2 ST FB WB - HARD FOAM INSULATION

Model	Vol. Weight		DF	DE	H	R1	R2	H1	H2	H3	H4	H5	H6	H7	H8	H9	H10	H11	H12	H13	H14	H15	K	P	M	D	B	A
	[lt]	[kg]																										
150	148	54	-	500	1414	-	1505	71	210	275	315	395	//	765	815	885	945	975	1065	1185	1185	//	Øi120/Øe180	-	3/4"	1 1/2"	3/4"	1 1/4"
200	189	65	-	550	1434	-	1540	71	220	285	325	405	//	811	855	915	960	985	1089	1195	1195	//	Øi120/Øe180	-	3/4"	1 1/2"	3/4"	1 1/4"
300	291	83	-	650	1486	-	1630	71	246	311	381	431	//	832	871	931	981	1011	1101	1221	1221	//	Øi120/Øe180	-	1"	1 1/2"	1"	1 1/4"
400	422	112	-	700	1766	-	1905	71	261	326	396	446	//	988	1033	1091	1143	1166	1286	1486	1486	//	Øi120/Øe180	-	1"	1 1/2"	1"	1 1/4"
500	498	134	-	750	1786	-	1945	71	271	346	411	466	//	1036	1076	1144	1186	1206	1331	1476	1476	//	Øi120/Øe180	-	1"	1 1/2"	1"	1 1/4"
800	789	232	750	900	2163	-	2350	101	338	428	483	548	//	1181	1243	1308	1362	1378	1598	1770	1708	1818	Øi170/Øe240	3/4"	1"	2"	1"	1 1/4"
1000	1038	272	850	1000	2217	-	2440	89	359	439	499	559	//	1279	1309	1364	1399	1444	1584	1819	1729	1839	Øi170/Øe240	3/4"	1 1/4"	2"	1"	1 1/2"
1500	1443	351	950	1100	2440	-	2685	109	340	425	575	545	//	1403	1450	1515	1550	1585	1825	2045	1965	2075	Øi300/Øe380	1"	1 1/2"	2"	1"	2"

BOLLY® 2 ST FB WC - DISMOUNTABLE SOFT FLEECE INSULATION

Model	Vol. Weight		DF	DE	H	R1	R2	H1	H2	H3	H4	H5	H6	H7	H8	H9	H10	H11	H12	H13	H14	H15	K	P	M	D	B	A
	[lt]	[kg]																										
800	789	232	750	950	2163	2205	2365	101	338	428	483	548	//	1181	1243	1308	1362	1378	1598	1770	1708	1818	Øi170/Øe240	3/4"	1"	2"	1"	1 1/4"
1000	1038	272	850	1050	2217	2270	2455	89	359	439	499	559	//	1279	1309	1364	1399	1444	1584	1819	1729	1839	Øi170/Øe240	3/4"	1 1/4"	2"	1"	1 1/2"
1500	1443	351	950	1150	2440	2500	2700	109	340	425	575	545	//	1403	1450	1515	1550	1585	1825	2045	1965	2075	Øi300/Øe380	1"	1 1/2"	2"	1"	2"

P.E.D. product designed and produced in conformity to the article 4.3 of directive 2014/68/UE - ErP Ecodesign directive 2009/125/CE

BOLLY® 2 ST FB

HEAT EXCHANGERS TECHNICAL DATA



Data have been calculated on following basis:

- 1) Primary circuit at T1 and proper energy source;
- 2) Production of DHW in continuous from 10 °C to t2;
- 3) DHW that can be taken in the first 10' and in the first hour from storage at t2, input 10 °C and output 45 °C;
- 4) Non-scaling sanitary water

UPPER
HEAT EXCHANGER

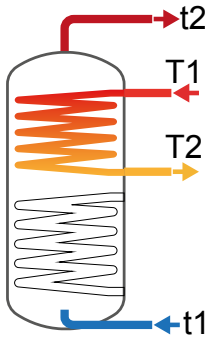

Model	Primary flow rate [m³/h]	Ignition time (minutes) from 10 °C to t2 and primary at T1				Maximum power exchange (kW) with primary at T1, secondary within 10-45 °C and constant use of DHW production				DHW continuous production lt/h within 10-45 °C and primary at T1			
		T1/t2				T1				T1			
		55/50	65/60	70/60	80/60	55	65	70	80	55	65	70	80
150	2	47	49	34	22	4,5	6,8	7,9	10,3	109	165	194	254
	1	52	64	38	24	4,1	6,2	7,2	9,4	100	151	177	231
200	2,5	46	48	33	21	5,7	8,6	10	13,1	138	210	247	322
	1,25	51	53	37	24	5,3	7,9	9,3	12	129	194	227	296
300	3	51	53	37	24	8	12,1	14,1	18,4	195	296	347	453
	1,5	57	59	41	27	7,5	11,2	13,1	16,9	183	274	321	416
400	3,5	55	57	40	26	11,4	17,2	20,2	26,2	279	423	496	646
	1,75	61	63	44	29	10,7	16	18,6	24	262	392	458	592
500	3,5	61	64	44	29	11,4	17,2	20,2	26,2	279	423	496	646
	1,75	68	70	49	32	10,7	16	18,6	24	262	392	458	592
800	6	68	71	49	32	18,3	27,6	32,3	41,9	447	677	794	1034
	3	75	78	54	36	17,2	25,6	29,8	38,5	419	628	733	949
1000	6	79	82	57	37	20,5	30,9	36,1	46,9	501	759	889	1157
	3	87	91	64	42	19,2	28,5	33,3	42,9	469	701	818	1057
1500	6	87	90	63	41	26	39	45,6	59,1	636	959	1123	1457
	3	97	102	71	46	24,2	35,8	41,6	53,6	592	879	1024	1318

Model	Primary flow rate [m³/h]	DHW produced in the first 10 minutes in lt/10' input 10 °C output 45 °C, storage at t2 and primary at T1				DHW produced in the first hour in lt/60' input 10 °C output 45 °C, storage at t2 and primary at T1				Heat exchanger pressure drop	
		T1/t2				T1/t2				[mmH ₂ O]	[mbar]
		55/50	65/60	70/60	80/60	55/50	65/60	70/60	80/60		
150	2	73	96	101	111	142	201	224	272	145,90	14,31
	1	72	94	98	107	135	189	210	253	40,41	3,96
200	2,5	92	121	127	139	179	254	283	343	275,70	27,04
	1,25	90	118	124	135	172	241	267	323	76,37	7,49
300	3	141	185	194	211	265	373	413	498	541,01	53,06
	1,5	139	181	189	205	255	355	393	469	149,87	14,70
400	3,5	211	276	288	313	388	544	603	723	1028,24	100,84
	1,75	208	271	282	304	374	519	572	679	284,83	27,93
500	3,5	229	299	311	336	406	567	625	745	1028,24	100,84
	1,75	227	294	305	327	392	542	595	702	284,83	27,93
800	6	401	521	541	581	684	950	1044	1236	911,70	89,41
	3	397	513	531	567	662	911	995	1168	252,55	24,77
1000	6	508	657	678	723	825	1137	1241	1456	1025,66	100,58
	3	502	647	666	706	799	1091	1184	1376	284,12	27,86
1500	6	691	891	919	974	1094	1499	1630	1897	1310,57	128,52
	3	684	878	902	951	1059	1435	1551	1786	363,04	35,60

BOLLY® 2 ST FB

HEAT EXCHANGERS TECHNICAL DATA



Data have been calculated on following basis:

- 1) Primary circuit at T1 and proper energy source;
- 2) Production of DHW in continuous from 10 °C to t2;
- 3) DHW that can be taken in the first 10' and in the first hour from storage at t2, input 10 °C and output 45 °C;
- 4) Non-scaling sanitary water

LOWER
HEAT EXCHANGER

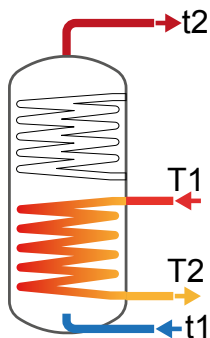

Model	Primary flow rate [m³/h]	Ignition time (minutes) from 10 °C to t2 and primary at T1				Maximum power exchange (kW) with primary at T1, secondary within 10-45 °C and constant use of DHW production				DHW continuous production lt/h within 10-45 °C and primary at T1			
		T1/t2				T1				T1			
		55/50	65/60	70/60	80/60	55	65	70	80	55	65	70	80
150	2	99	102	71	46	6,6	10	11,7	15,2	162	246	288	371
	1	111	116	81	53	6,1	9,1	10,6	13,2	149	223	260	336
200	2,5	92	95	66	43	9	13,5	15,8	20,5	220	332	389	506
	1,25	103	107	75	49	8,3	12,3	14,4	18,5	203	303	354	456
300	3	97	101	70	45	13,5	20,2	23,6	30,6	331	498	583	756
	1,5	106	111	78	51	12,5	18,5	21,5	27,5	307	455	529	680
400	3,5	105	110	76	50	16,9	25,4	29,6	38,3	416	625	731	947
	1,75	117	122	86	57	15,4	23,2	26,9	34,5	387	571	664	853
500	3,5	111	116	81	53	20,2	30,1	35,1	45,3	496	742	867	1121
	1,75	126	131	93	61	18,7	27,3	31,7	40,6	459	674	782	1000
800	6	116	120	84	55	30,3	45,4	53	68,6	746	1120	1309	1695
	3	131	136	96	64	28,2	41,4	48,1	61,6	692	1021	1186	1521
1000	6	114	119	84	56	38,9	57,9	67,5	87	958	1429	1667	2151
	3	132	138	98	65	35,5	52,2	60,4	77	882	1288	1492	1903
1500	6	162	168	119	78	41	61	71	91,5	1009	1504	1753	2261
	3	189	197	139	92	37,7	54,9	63,4	80,7	927	1352	1564	1993

Model	Primary flow rate [m³/h]	DHW produced in the first 10 minutes in lt/10' input 10 °C output 45 °C, storage at t2 and primary at T1				DHW produced in the first hour in lt/60' input 10 °C output 45 °C, storage at t2 and primary at T1				Heat exchanger pressure drop	
		T1/t2				T1/t2				[mmH ₂ O]	[mbar]
		55/50	65/60	70/60	80/60	55/50	65/60	70/60	80/60		
150	2	195	251	258	272	298	407	440	507	218,85	21,46
	1	193	247	253	266	287	388	418	479	60,62	5,95
200	2,5	253	325	335	354	392	536	581	675	441,12	43,26
	1,25	250	321	329	346	378	512	553	635	122,19	11,98
300	3	388	499	513	542	597	814	882	1021	927,45	90,95
	1,5	384	492	504	529	578	780	839	960	256,91	25,19
400	3,5	550	706	723	759	814	1101	1186	1359	1480,67	145,20
	1,75	546	697	712	744	791	1058	1133	1284	410,16	40,22
500	3,5	651	834	855	897	965	1304	1404	1607	1850,84	181,50
	1,75	645	822	840	877	935	1249	1336	1510	512,70	50,28
800	6	1026	1314	1345	1410	1499	2023	2174	2483	1538,50	150,87
	3	1017	1297	1325	1381	1455	1944	2076	2344	426,18	41,79
1000	6	1345	1720	1759	1840	1952	2625	2815	3202	1994,35	195,58
	3	1332	1696	1730	1799	1891	2512	2675	3004	552,45	54,18
1500	6	1870	2378	2419	2504	2509	3330	3530	3936	2108,31	206,75
	3	1856	2352	2388	2459	2443	3209	3378	3722	584,02	57,27

BOLLY® 2 ST FB

UPPER HEAT EXCHANGERS PRESSURE DROP



Heat exchangers surface [m ²]	
150	0,4
200	0,5
300	0,7
400	1
500	1
800	1,6
1000	1,8
1500	1,9

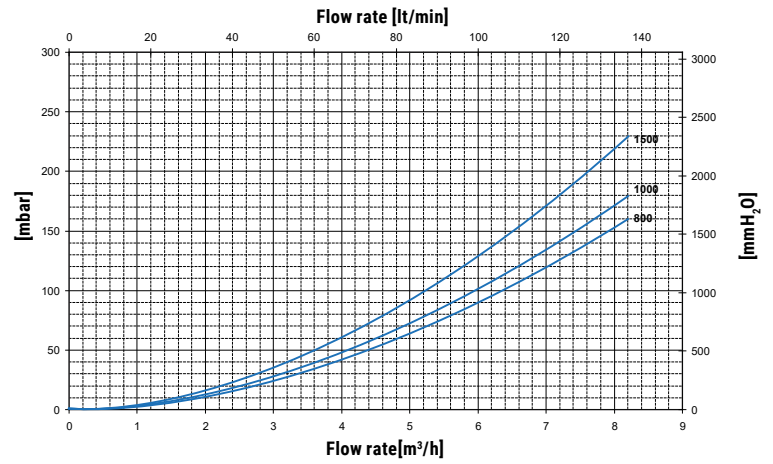
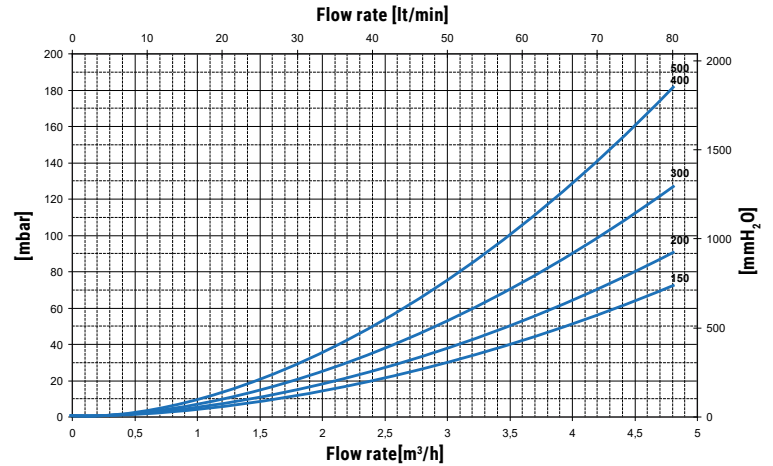

LOWER HEAT EXCHANGERS PRESSURE DROP

Heat exchangers surface [m ²]	
150	0,6
200	0,8
300	1,2
400	1,5
500	1,8
800	2,7
1000	3,5
1500	3,8

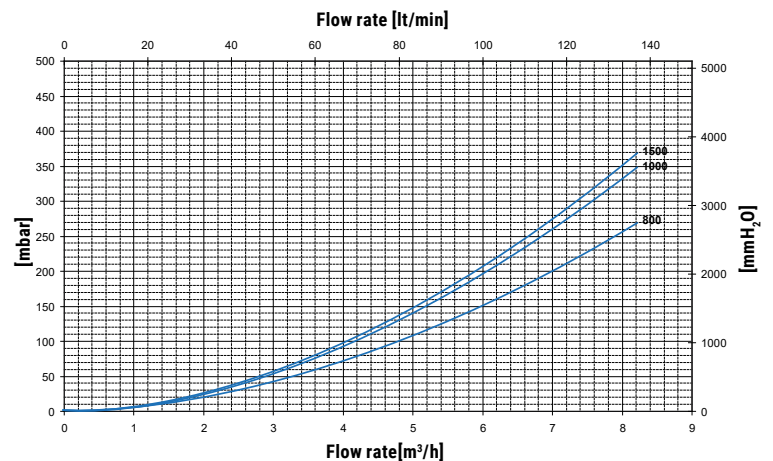
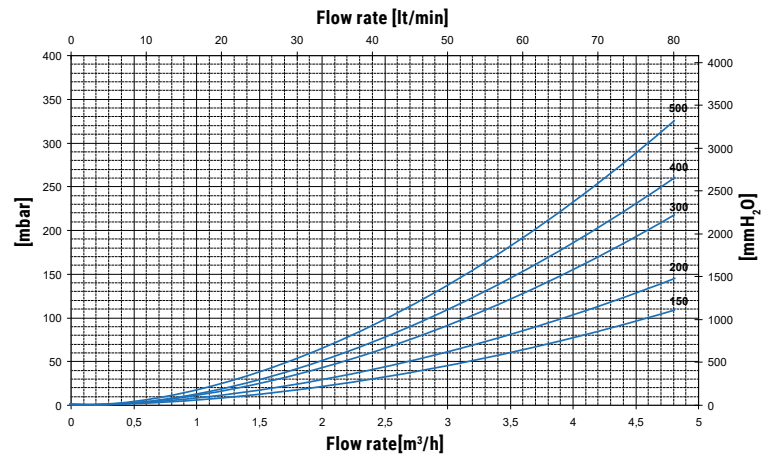

BOLLY® 2 ST FB

UPPER HEAT EXCHANGERS TECHNICAL DATA



Heat Exchanger output referred to temperature and flow rate of primary circuit and with secondary at 10/45°C at maximum withdrawal of producible DHW (Upper limit of the curves referred to maximum primary flow rate in the heat exchanger, while the lower limit in the curves refer to the minimum primary flow rate).

For Lower heat exchangers technical data- see BOLLY® 1 ST

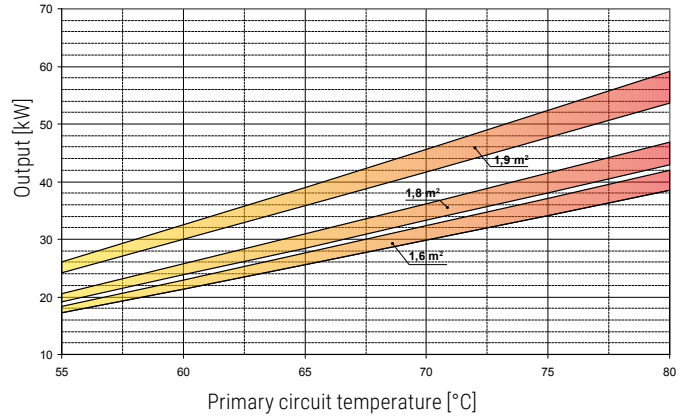
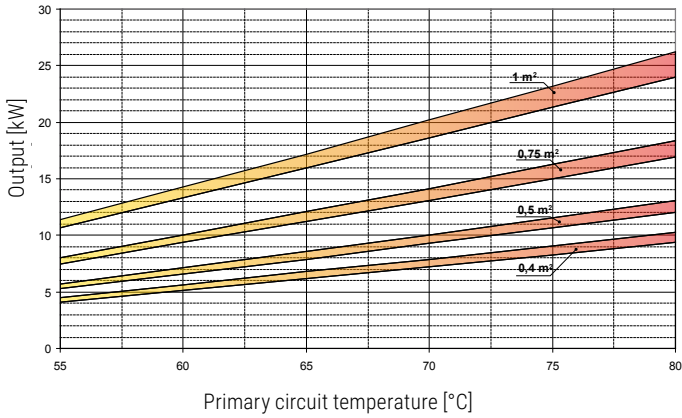

Heat exchanger	0,4 m ²		0,5 m ²		0,75 m ²		1 m ²	
	MAX	MIN	MAX	MIN	MAX	MIN	MAX	MIN
Flow rate [m ³ /h]	2	1	2,5	1,25	3	1,5	3,5	1,75

Heat exchanger	1,6 m ²		1,8 m ²		1,9 m ²	
	MAX	MIN	MAX	MIN	MAX	MIN
Flow rate [m ³ /h]	6	3	6	3	6	3

FOR LOWER HEAT EXCHANGERS TECHNICAL DATA- SEE BOLLY® 1 ST

EXAMPLE OF INSTALLATION WITH BOLLY® 2 ST FB

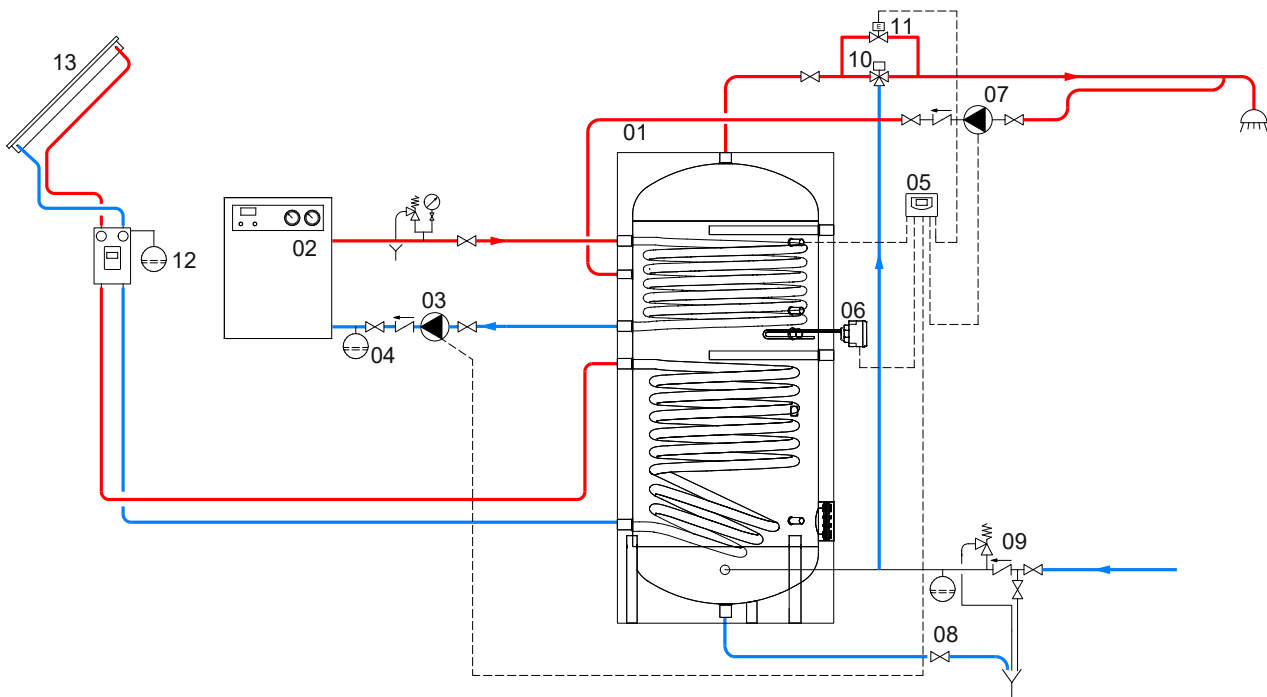

1 Bolly® 2 ST FB	5 Electronic Control/thermostat	9 Hydraulic safety group	13 Solar panels
2 Generator	6 Electric immersion heater (optional)	10 Thermostatic mixing valve	
3 Circulation group	7 D.H.W. recirculation group	11 By-pass solenoid valve	
4 Expansion vessel	8 Blowdown valve	12 Solar system circulation group	

The following schemes are purely illustrative. To realize the installation, always refer to a qualified technician.