

# BOLLY® 1 PDC

POLYWARM® COATED TANK FOR DHW ACCUMULATION SPECIFIC FOR COMBINATION WITH HEAT PUMP



### APPLICATION

Production and storage of domestic hot water (DHW). All the connections are aligned on the front and on the back for quick and easy installation.

### MATERIAL

Mild steel Polywarm® coated (Attestation ACS - SSICA - EN 16421 - WRAS).

### EXCHANGE MODULE

Counter-flow heat exchanger system with heat load from the top.

### INSULATION

- HARD: High thermal insulation with ecological polyurethane hard foam.
- HARD FOAM (CLASS "A" MODELS): rigid polyurethane foam for high thermal insulation with a vacuum sheet of highly insulating material. Grey PVC external lining.

### CATHODE PROTECTION

Magnesium anode.

### DRAIN

External confluence through drain connection.

### GASKET- FLANGE PLATE

Silicone gaskets suitable for water intended for human consumption (tested according to 98/83/CE); Inspection flange with connection for electric heater.

### WARRANTY

5 years (tank). See general sales conditions and warranty for electrical parts.

### ACCESSORIES AND SPARE PARTS

See Accessories section for the entire list.

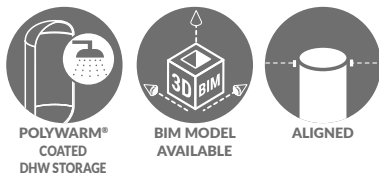

POLYWARM® COATED DHW STORAGE

BIM MODEL AVAILABLE

ALIGNED



### BOLLY® 1 PDC WB

Model	HARD FOAM INSULATION Art. Nr.	Heat pump max output [kW]	ENERGY EFFICIENCY CLASS
			ErP
300	3104162330022	15	B
500	3104162330023	22	C



### BOLLY® 1 PDC WB CLASS A

Model	HARD FOAM INSULATION Art. Nr.	Heat pump max output [kW]	ENERGY EFFICIENCY CLASS
			ErP
300	3104162330025	15	A
500	3104162330026	22	A

NEW



### BOLLY® 1 PDC DOUBLE CYCLE WB

Model	HARD FOAM INSULATION Art. Nr.	Heat pump max output [kW]	ENERGY EFFICIENCY CLASS
			ErP
500	3104162330057	30	C
800	3104162330058	40	B
1000	3104162330059	40	C

## ACCESSORIES

### Titanium anode

Art. Nr.	Model
5240000000008	300
5240000000011	500-1000



### Electric immersion heater

Art. Nr.	Output [kW]
5240000000052	2



### HEAT MANAGER + electric immersion heater 1,5 kW + probe +3m cable

Art. Nr.	ELECTRIC IMMERSION HEATER
5240000000074	1,5 kW
5240000000075	2 kW
5240000000076	3 kW



### Thermometer

Art. Nr.
5032240000107
5 units box



# BOLLY® 1 PDC

POLYWARM® COATED TANK FOR DHW ACCUMULATION SPECIFIC FOR COMBINATION WITH HEAT PUMP

**STORAGE    EXCHANGE MODULE**

Pmax	Tmax	Pmax	Tmax
10 bar	90 °C	10 bar	110 °C

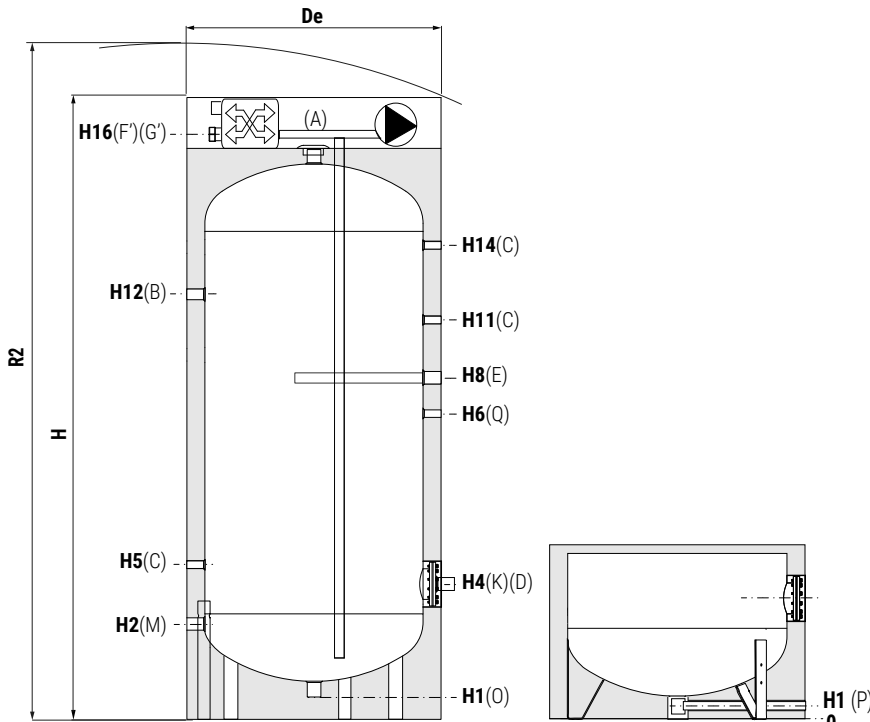

for models 800-1000

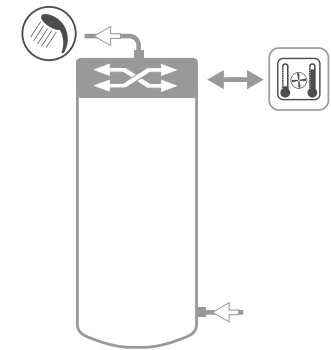
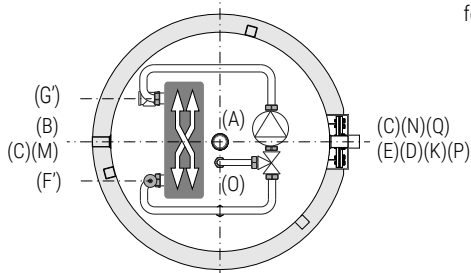

See TECHNICAL SUPPORT chapter for example of installation

- A** Domestic hot water outlet 1" 1/4 G F

---

- B** Recirculation. 1" G F

---

- C** Connection for instrumentation. 1/2" G F

---

- D** Connection for electric immersion heater

---

- E** Connection for magnesium anode 1" 1/4 G F

---

- F'** Primary circuit inlet.

---

- G'** Primary circuit outlet

---

- K** Flange for inspection

---

- M** Domestic water inlet. 1" G F

---

- O** Drain

---

- P** Drain > 500 lt

---

- Q** Connection for thermometer 1/2" G F (Only BOLLY PDC DOUBLE CYCLE)

Model	Volume [lt]	De	H	R2	H1	H2	H4	H5	H6	H8
<b>300</b>	291	650	1680	1810	71	241	381	431	//	871
<b>500</b>	497	750	2030	2170	71	271	411	466	956	1076
<b>800</b>	789	900	2430	2600	101	338	483	548	1123	1243
<b>1000</b>	1038	1000	2475	2675	89	359	499	559	1190	1310

Model	[mm]				A	O-P	K	D	F'-G'
	H11	H12	H14	H16					
<b>300</b>	991	1101	1221	1522	1" 1/4	1" 1/4	Øi1200e180	1" 1/2	1"
<b>500</b>	1196	1331	1476	1812	1" 1/4	1" 1/4	Øi1200e180	1" 1/2	1"
<b>800</b>	1378	1598	1708	2196	1" 1/4	3/4"	Øi1700e240	2"	1"
<b>1000</b>	1444	1584	1729	2260	1" 1/2	3/4"	Øi1700e240	2"	1"

- -30% reduction of the D.H.W. production time for major comfort
- 70lt of DHW (45 °C) in only 15 min, with the possibility of heating only the necessary volume of water
- More time for the heat pump to be dedicated to heating or cooling
- Energy focused where needed: all the energy produced with the heat pump concentrated in the upper part of the tank.

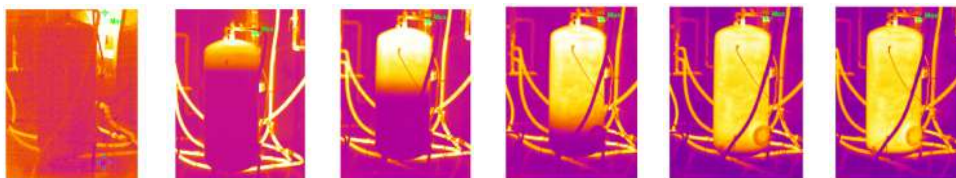

Series of thermographs that illustrate the efficiency of the Cordivari patent through the excellent thermal stratification

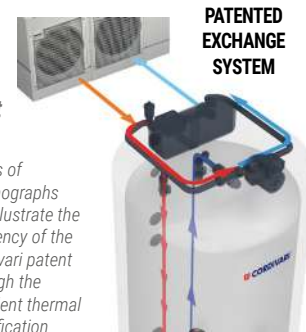

**PATENTED EXCHANGE SYSTEM**

# BOLLY® PDC

## TECHNICAL DATA AND EXAMPLE OF INSTALLATION

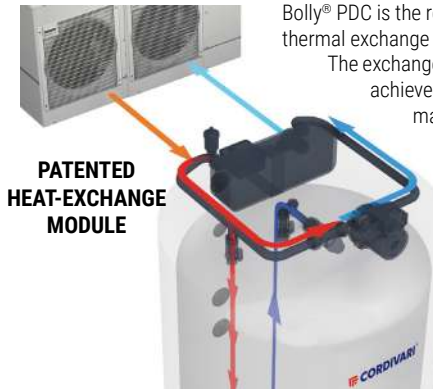

Bolly® PDC is the result of a continuous research aimed to develop a unique calorifier in its field. It is in fact the only patented system of thermal exchange actually on the market, specifically conceived for installation with heat pumps.

The exchange and stratification system is conceived to self-balance: only part of the heated water, proportionate to the temperature achieved during the thermal exchange, is pushed in the tank from the top. This way the water added in the upper part is at maximum desired temperature while fresh water coming from the lower part of the tank goes to the exchanger.

This leads to many advantages such as the increased efficiency of the heat pump C.o.p, the achievement of a perfect thermal stratification, that allows to profit immediately of the hot water. This also allows to heat only part of the tank reducing energy waste.

The innovative Bolly® PDC, combined with a heat pump, thanks to the new patented exchange group is able to guarantee 30 % higher performances compared to a generic, traditional calorifier in terms of ignition time and thermal exchange efficiency.

Laboratory tests and researches conducted on the stratification process confirm that the use of Bolly® PDC in a heat pump installation means an increased comfort and about a 15% reduction of electric consumption while extending the generator lifecycle, reducing its on/off.

### Bolly® PDC (model 500), connected to 12kW heat pump

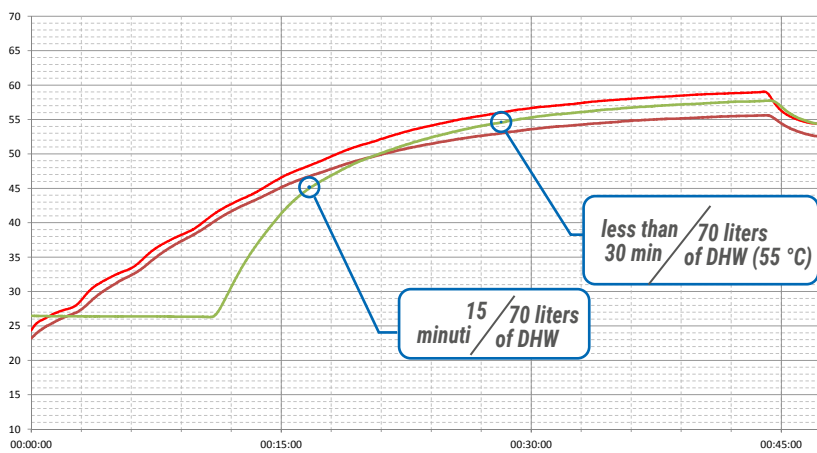

— T1 HEAT PUMP — T2 HEAT PUMP — DHW Temperature

- 😊 -30% ignition time and consequent better efficiency of HP in heating/cooling phase.
- 😊 70 L. of DHW at 55 °C in just 30 minutes, with possibility to heat only the necessary required water volume.
- 😊 Optimizing the time necessary for the HP for heating and cooling the room.
- 😊 The energy produced by Heat pump is concentrated in the Domestic hot water in the upper part of the storage volume

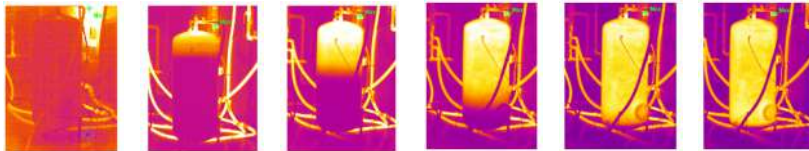

**BOLLY® PDC**  
Upper loading and improved thermal stratification thanks to the patented heat exchanger group.

## TECHNICAL DATA AND EXAMPLE OF INSTALLATION

The peculiarity of the Bolly® PDC heat exchange module consists in the possibility of loading the thermal power in the DHW storage from above, in order to prepare hot water for the user at the right temperature after few minutes of operation. Obviously, the quantity of DHW available will depend on the actual time of operation, the initial temperature of the sanitary cold water, and the thermal output of the generator.

The typical operating condition of an hydronic heat pump generator is to provides 55 °C at the primary inlet with 5 °C deltaT on the return side. The presence of a thermostatic mixer on the domestic circuit allows the appliance to adjust the performance and the efficiency in the heating phase. With the mixer at minimum (in practice with the mixer excluded) the maximum performance is obtained in terms of exchangeable output at the beginning of the heating process (values shown in the catalog). But under these conditions, as the temperature rises on the secondary side the exchanged output will go down.

Much more interesting is to examine the behavior of the exchange module with the mixer in position "2" which corresponds to primary at 55 °C and production of DHW at 50 °C, with the peculiarity that this value of 50 °C is independent from the temperature of the cold water.

Under these conditions the exchanged output remains constant for all the time necessary

to heat the storage volume and, independently of the initial storage temperature.

Summing up:

- PRIMARY INLET = 55 °C
- MIXER POSITION = 2
- DHW INLET TEMPERATURE INTO THE STORAGE FROM EXCHANGE MODULE = 50 °C
- BOLLY® PDC 300 EXCHANGEABLE OUTPUT = 15 KW
- BOLLY® PDC 500 EXCHANGEABLE OUTPUT = 22 KW
- BOLLY® PDC 800 EXCHANGEABLE OUTPUT = 26 KW
- DELTAT AT PRIMARY = 5 °C (RETURN TO GENERATOR 50 °C)

Under these conditions the producibility of DHW (and therefore the storage heating time) will depend on the initial storage temperature corresponding to the water inlet temperature.

Model Bolly® PDC	Primary circuit inlet temperature T1 [°C]	Mixer position	Output [kW]	Initial storage temperature 10°C		Initial storage temperature 20°C		Initial storage temperature 25°C	
				DHW production at 50°C [lt/min]	Storage heating time [min]	DHW production at 50°C [lt/min]	Storage heating time [min]	DHW production at 50°C [lt/min]	Storage heating time [min]
300	55	2	15	5,1	57	6,8	43	8,2	36
500			22	6,8	73	9,1	55	10,9	46
800			26	8,8	89	11,8	67	14,2	56

# BOLLY® PDC DOUBLE CYCLE

## NEW BOLLY PDC DOUBLE CYCLE

**Cordivari patented Bolly PDC is a range of tanks specifically optimized for heat pumps.**

These tanks can integrate up to 3 different energy sources and guarantee approx. +30% performance compared to tank- in-tank or traditional ones and savings of 15% on electricity consumption of the heat pumps, thanks to the patented stratified exchange system.

This unique range is now extended with the DOUBLE CYCLE patented solutions, aimed to optimize the performance also for medium and large sized systems:

Heat exchange takes place in two separate phases:

CYCLE ONE heats only the upper part of the tank to allow an initial and very rapid availability of DHW at comfort temperature;

CYCLE TWO which, after cycle one has ended, heats separately the lower part of the tank avoiding any turbulence in the upper part. This completes the heating of the entire cylinder, achieving the best balance between thermal comfort of the building and DHW, improving savings and energy efficiency.

### CYCLE ONE:

Only heating of the higher part of the cylinder (V1). No heat exchange in the bottom part (V2).

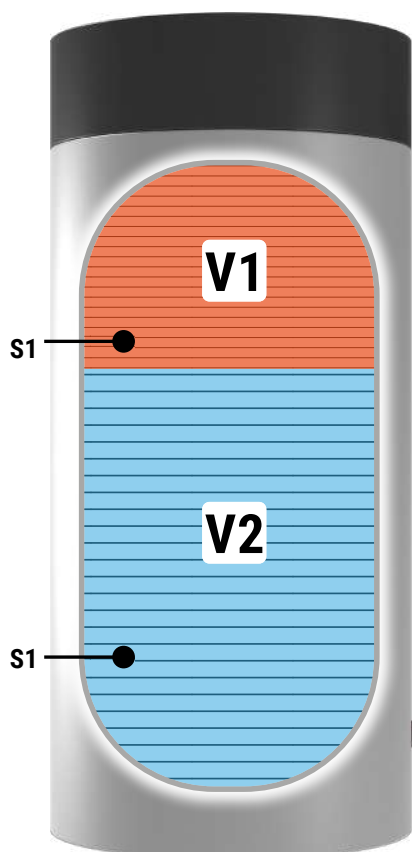

### CYCLE TWO

Perfect thermal stratification: heating of the bottom part of the cylinder (V2). No mixing in the higher part (V1).

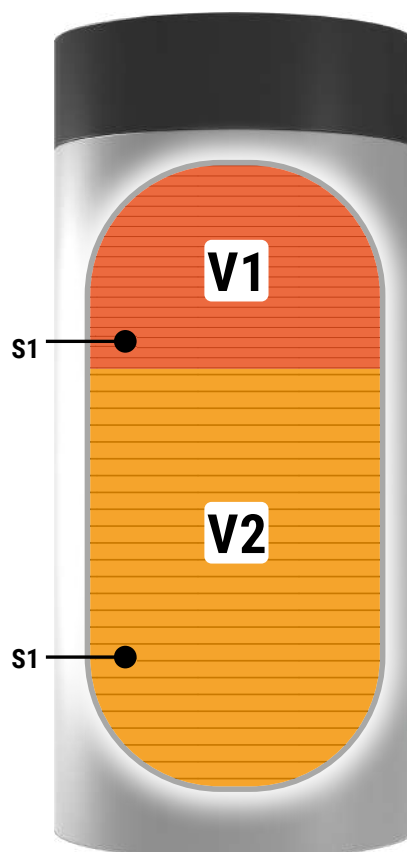

### THERMOGRAPHY

The below thermography show the perfect stratification in the two phases of the heat exchange.

