

ardesia® CONNECTIONS

To facilitate the desired choice, we have prepared standard configurations with pre-installed reducing bushes and caps. When placing an order, specify the required version. If the type of connection is not specified, the radiator will be supplied with open connections. To order fittings and accessories.

STANDARD CONFIGURATIONS

Standard configurations, except for connection "000" or special executions excluded, include airvent end caps and bushes already mounted. It is necessary to specify the desired combination (example: 001, 002, 003, D08, M02, AS3 ecc...).

PLEASE NOTE: besides the configurations hereby presented, all configurations with diameters of 3/4" • 1/2" • 3/8" • 1/4" are available.

LEGEND			
	In		Out
	Airvent		Connection 1/2"
	Movable Diverter		Welded Diverter
	End cap		Thermostatic head
	Bidirectional		

SIDE AND OPPOSITE CONNECTIONS

Airvent included

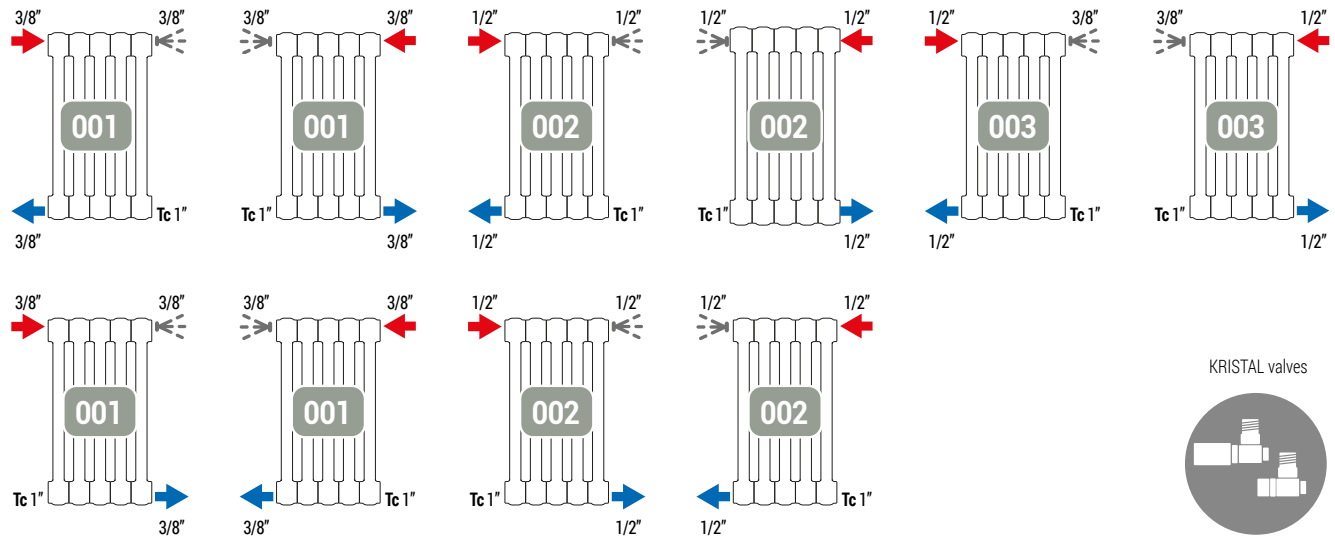

BOTTOM-SIDE CONNECTIONS

Airvent included

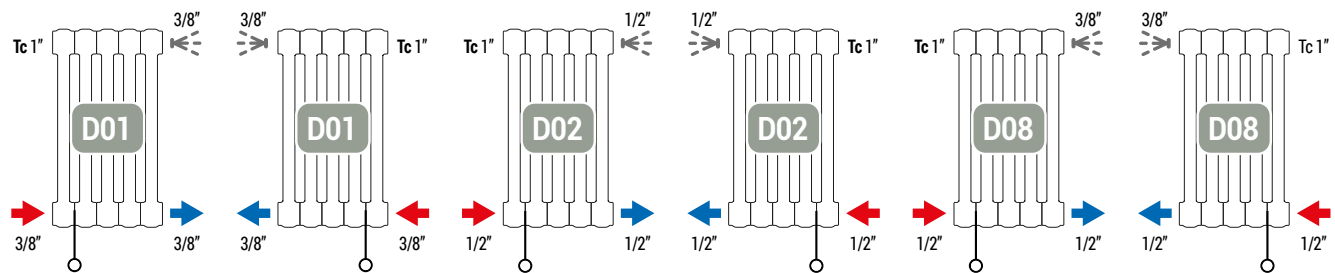

UNIVERSAL CONNECTIONS

Airvent included

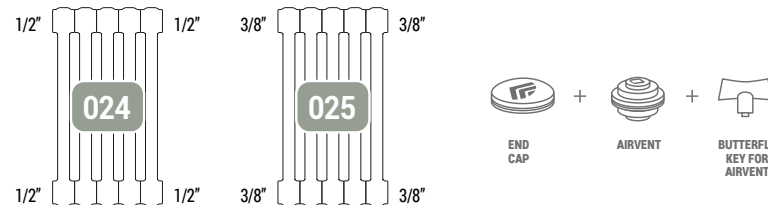

CONNECTIONS FOR NIPPLING OPERATION

4 open connections with 1" threading end cap, reducing bushes and airvent are supplied separately, on demand.



Ideal for wholesalers that wish to have a stock of radiators ready for use. The "000" connection for nipping operation allows to have batteries of several dimensions and with an almost endless number of heating sections.

BIDIRECTIONAL CONNECTIONS

Airvent included

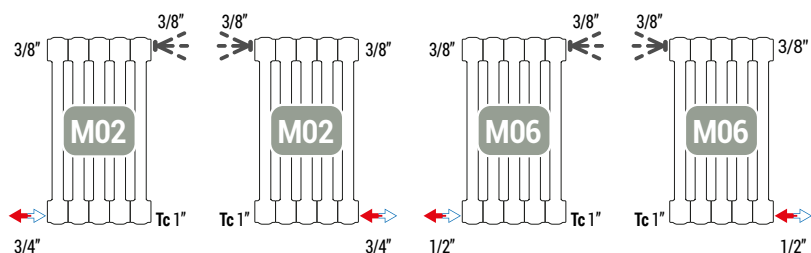

Valve Bidirectional Kristal Cordivari only for M6 bidirectional connection for batteries from 3 up to 20 sections. (see ACCESSORIES).

BIDIRECTIONAL CONNECTIONS

Airvent included

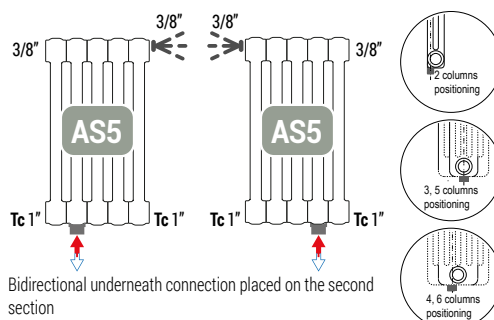

Bidirectional underneath connection placed on the second section

OPPOSITE SPECIAL CONNECTIONS

Airvent included

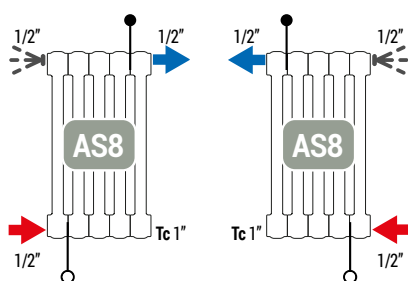

WITH UPPER SLEEVES CONNECTIONS

Airvent included

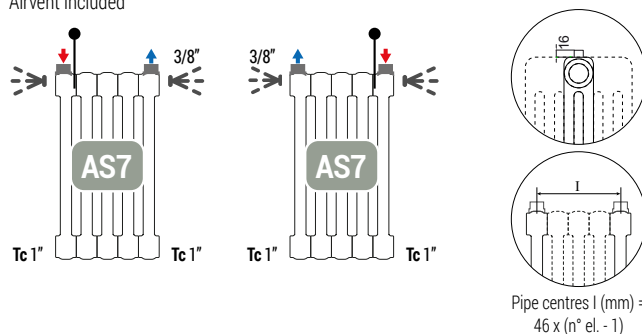

UNDERNEATH WELDED SLEEVES CONNECTIONS

Airvent included

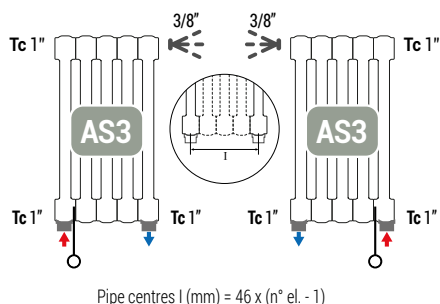

Pipe centres different from standard are available on demand.

Airvent included

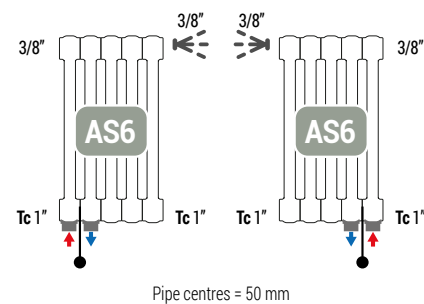

Airvent included

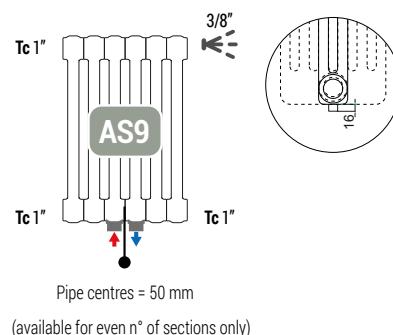

WELDED UNDERNEATH SLEEVES WITH PIPE CENTRES 50 MM 1/2" AND THERMOSTATIC HEAD MOUNTED^(*)

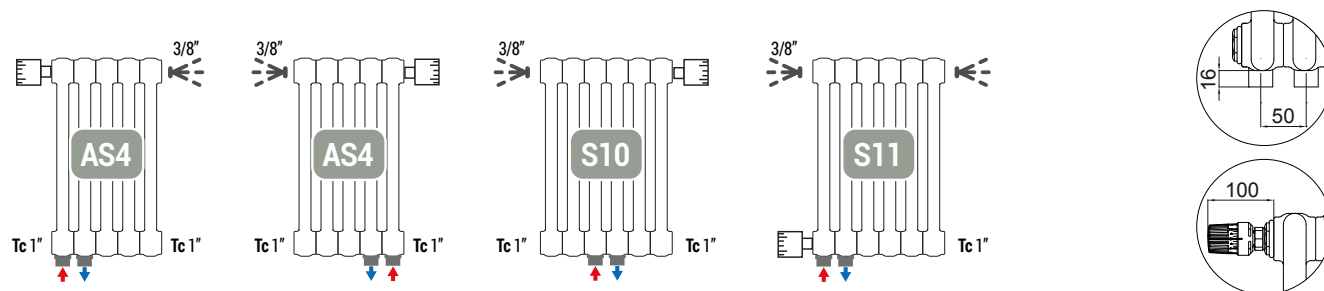

^(*) Valve unit and Liquid thermostatic head Oventrop with liquidfunctioning in accordance with UNI EN 215:2007 regulation.