

# INTERKA SOLAR

## POLYWARM® CALORIFIER WITH DOUBLE WALL EXCHANGER SPECIFIC FOR THERMOSYPHON SOLAR THERMAL SYSTEMS



### APPLICATION

Production and storage of domestic hot water (DHW).

### MATERIAL

Mild steel Polywarm® coated (Attestation ACS - SSICA - EN 16421 - WRAS).

### HEAT EXCHANGER

Double wall heat exchanger.

### INSULATION

High thermal insulation with ecological polyurethane hard foam.

External coating in metal sheet protected by a particular anticorrosive treatment.

### CATHODE PROTECTION

Magnesium anode.

### WARRANTY

5 years (See general sales conditions and warranty)

### ACCESSORIES AND SPARE PARTS

See Accessories section for the entire list.



POLYWARM®  
COATED  
DHW STORAGE



### INTERKA SOLARE WB

Model	HARD FOAM INSULATION Art. Nr.	DOUBLE WALL EXCHANGER		ENERGY EFFICIENCY CLASS 
		Surface [m²]	Volume [lt]	
150	3068160980166	0,80	8,0	B
200	3068160980167	1,20	12,0	B
300	3068160980168	2,05	21,0	B

[cordivari.com/erp](http://cordivari.com/erp)

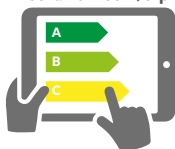

On line ErP label tool

## ACCESSORIES

### Electric immersion heater with cover

Art. Nr.	Output	Con- nection	
5240000000062	1,5 kW	1" 1/4	
See CORDIVARI INTEGRATED THERMAL SOLAR SYSTEMS catalogue			

### HEAT MANAGER

See CORDIVARI INTEGRATED THERMAL SOLAR SYSTEMS catalogue



### Magnesium anode

ART. NR.	Model	
5200000041008	150	
5200000041009	200,300	
2 units box		

# INTERKA SOLARE

POLYWARM® CALORIFIER WITH DOUBLE WALL EXCHANGER  
SPECIFIC FOR THERMOSYPHON SOLAR THERMAL SYSTEMS

STORAGE		HEAT EXCHANGER	
Pmax	Tmax	Pmax	Tmax
6 bar	90 °C	2,5 bar	99 °C



—CORDIVARI—Lab

TÜV Rheinland Energie und Umwelt GmbH states that test procedures and Cordivari LAB are certified conforming to European standard EN 15332, as indicated by Ecodesign ErP Directive.

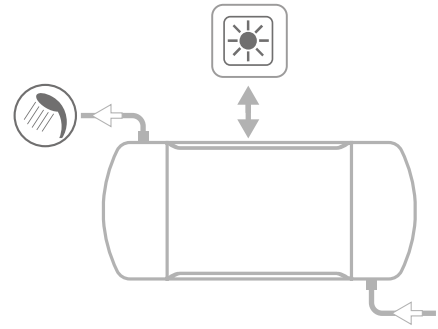

- A** Domestic hot water outlet 3/4" G F

---

- B** Connection for magnesium anode

---

- C** Solar collector connection 3/4" G F

---

- D** Solar collector connection 3/4" G F

---

- E** Domestic water inlet 3/4" G F

---

- F** Overflow volume 1/2" G F

---

- G** Instrumentation 1/2" GAS F

---

- H** Electric immersion heater 1" 1/4 G F (optional)

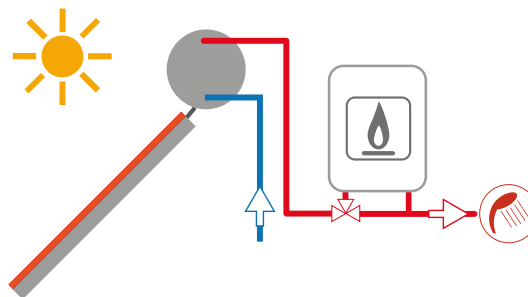
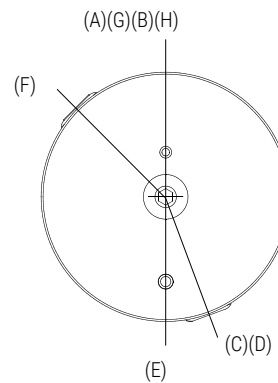
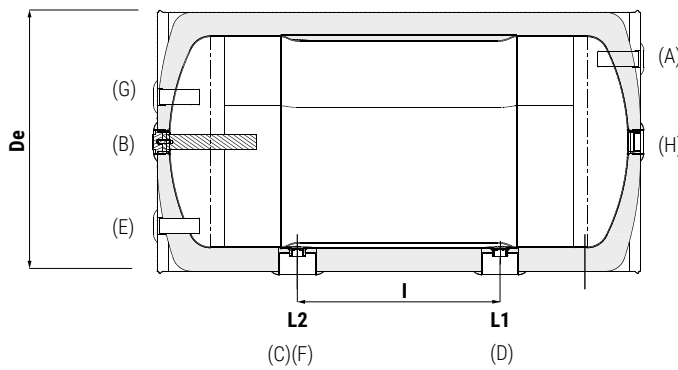

Model	Volume [lt]	De	L	I [mm]	L1	L2
<b>150</b>	143	550	1026	430	298	728
<b>200</b>	183	550	1286	640	323	963
<b>300</b>	270	550	1840	1090	375	1465