

EXTRA 1 WX

POLYWARM® COATED CALORIFIER WITH 1 EXTRACTABLE STAINLESS STEEL HEAT EXCHANGER



APPLICATION

Production and storage of domestic hot water (DHW).

MATERIAL

Mild steel Polywarm® coated (Attestation ACS - SSICA - EN 16421 - WRAS - WRAS)

HEAT EXCHANGER

Stainless steel 316L Antilegionella® heat exchanger, with tubes bent to the bottom

INSULATION

- HARD: High thermal insulation with ecological polyurethane hard foam.

- SOFT: NOFIRE® polyester fleece 100% made of recyclable material, with high thermal insulation. Fire resistance class B-s2d0 according to EN 13501.

Grey PVC external lining.

CATHODE PROTECTION

Magnesium anode. Models > 1500 n° 2 magnesium anodes.

DRAIN

External confluence through drain connection. Models > 1000 external confluence through drain pipe.

GASKET- FLANGE PLATE

Silicone gaskets suitable for water intended for human consumption (tested according to 98/83/CE), max temperature up to 200°C. Mild steel exchanger head with anticorrosion treatment.

WARRANTY

5 years (See general sales conditions and warranty)

ACCESSORIES AND SPARE PARTS: See Accessories section for the entire list.

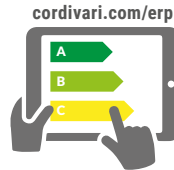
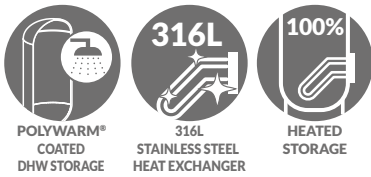

On line ErP label tool



EXTRA 1 WXB

Model	HARD FOAM INSULATION Art. Nr.	HEAT EXCHANGER SURFACE [m²]	ENERGY EFFICIENCY CLASS ErP
200	3072162360122	0,5	B
300	3072162360123	0,75	C
500	3072162360124	1	C
800	3072162360125	1,5	B
1000	3072162360126	2	C
1500	3072162360127	3	C
2000	3072162360128	4	B



EXTRA 1 WXC

Model	DISMOUNTABLE SOFT FLEECE INSULATION Art. Nr.	HEAT EXCHANGER SURFACE [m²]	ENERGY EFFICIENCY CLASS ErP
500	3072162360134	1	C
800	3072162360135	1,5	C
1000	3072162360136	2	C
1500	3072162360137	3	C
2000	3072162360138	4	C
2500	3072162360113	5	
3000	3072162360109	6	
4000	3072162360110	8	
5000	3072162360112	10	

ACCESSORIES

ELECTRIC IMMERSION HEATERS

Mod.	MONOPHASE		
	1,5 kW	2 kW	3 kW
	5240000000051	5240000000052	5240000000053
	Ignition time from 10 °C to 45 °C with electric immersion heaters [min]		
200	49	87	65
300	76	136	102
500	127	228	171
800	178	318	239
1000	243	436	327
1500	288	516	387
2000	443	793	595
2500	577	1033	775
3000	577	1033	775
4000	797	1428	1071
5000	1040	1864	1398

THREEPHASE				
4 kW	5 kW	6 kW	9 kW	12 kW
5240000000047	5240000000048	5240000000049	5240000000050	5240000000031
Ignition time from 10 °C to 45 °C with electric immersion heaters [min]				
33	//	//	//	//
51	//	//	//	//
85	68	57	//	//
120	96	80	//	//
163	131	109	73	54
194	155	129	86	65
297	238	198	132	99
387	310	258	172	129
387	310	258	172	129
535	428	357	238	178
699	559	466	311	233

HEAT MANAGER kit + electric resistance with probe and 3m cable

Art. Nr.	ELECTRICAL RESISTANCE
5240000000074	1,5 kW
5240000000075	2 kW
5240000000076	3 kW

See Accessories section

Titanium electronic anode

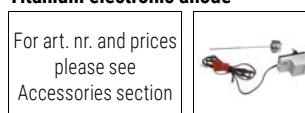

For art. nr. and prices please see Accessories section

Thermometer

Art. Nr.
5032240000107
5 units box

EXTRA 1 WX

POLYWARM® COATED CALORIFIER WITH 1 EXTRACTABLE STAINLESS STEEL HEAT EXCHANGER

Model	STORAGE		HEAT EXCHANGER	
	Pmax	Tmax	Pmax	Tmax
200 ÷ 1000	8 bar	90 °C	12 bar	110 °C
1500 ÷ 5000	6 bar			



—CORDIVARI Lab

TÜV Rheinland Energie und Umwelt GmbH states that test procedures and Cordivari LAB are certified conforming to European standard EN 15332, as indicated by Ecodesign ErP Directive.

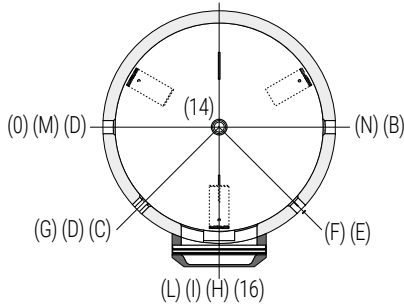
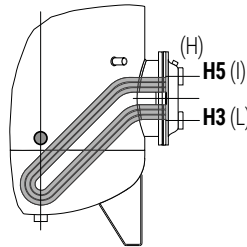
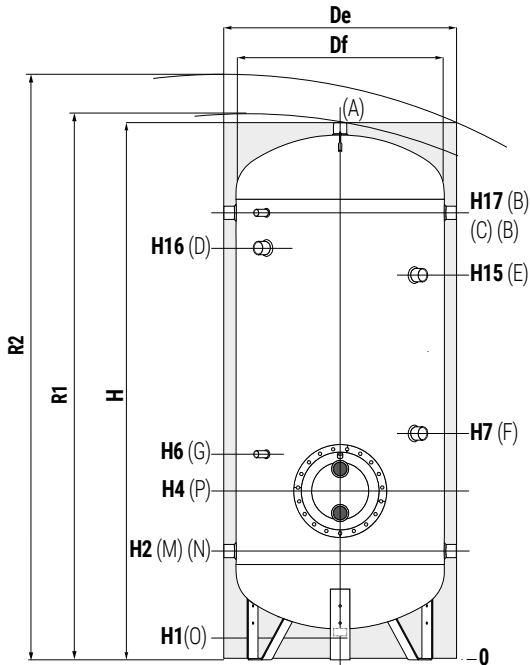
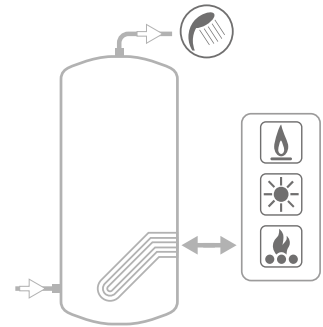

- A** Domestic hot water outlet
- B** Recirculation / Domestic hot water outlet
- C** Connection for instrumentation 1/2" G F
- D** Connection for electric immersion heater 1 1/2" F. For models > 800 connection 2" F
- E** Connection for 2nd magnesium anode 1 1/4" F (only for models > 1500)
- F** Connection for magnesium anode 1" 1/4 G F
- G** Connection for instrumentation 1/2" G F
- H** Heat exchanger drain 3/8" F
- I** Primary circuit inlet 1" F. For models > 500 connection 2" F
- L** Primary circuit outlet 1" F. For models > 500 connection 2" F
- M** Domestic cold water circuit inlet
- N** Alternative domestic cold water circuit inlet or connection for more tanks in series
- O** Drain
- P** Heat exchanger flange

Only the models from 1500 to 5000 are equipped with a practical **skirt** support which facilitate the handling with transpallets and forklifts. Also, discharge piping already mounted to allow **total emptying**.

EXTRA 1 WXB - HARD FOAM INSULATION

Model	Volume Weight		De	H	R2	H1	H2	H3	H4	H5	H6	H7	H15	H16	H17	P	B		
	[lt]	[kg]															M-N	A	O
	[mm]																Connections F		
200	191	52	550	1449	1560	85	325	360	410	460	520	650	//	1075	1185	Øi220/Øe300	1"1/4	1"1/4	1"1/4
300	292	65	650	1499	1640	85	350	385	435	485	545	735	//	1100	1210	Øi220/Øe300	1"1/4	1"1/4	1"1/4
500	500	83	750	1800	1960	85	375	410	460	510	570	760	//	1329	1485	Øi220/Øe300	1"1/4	1"1/4	1"1/4
800	794	139	900	2135	2330	85	405	450	540	630	690	870	//	1610	1765	Øi300/Øe380	1"1/4	1"1/2	1"1/4
1000	1042	181	1000	2221	2450	105	458	503	593	683	743	993	//	1664	1818	Øi300/Øe380	1"1/2	2"	1"1/2
1500	1445	224	1100	2415	2660	109	440	585	675	765	825	1075	//	1895	2050	Øi300/Øe380	1"1/2	2"	1"
2000	1978	279	1300	2492	2820	91	467	587	692	797	867	842	1952	1877	2057	Øi350/Øe430	2"	2"	1"

EXTRA 1 WXC - DISMOUNTABLE SOFT FLEECE INSULATION

Model	Vol. Weight		De	Df	H	R1	R2	H1	H2	H3	H4	H5	H6	H7	H15	H16	H17	P	B		
	[lt]	[kg]																	M-N	A	O
	[mm]																Connections F				
500	500	90	870	650	1841	1998	2090	101	416	451	501	551	611	801	//	1370	1526	Øi220/Øe300	1"1/4	1"1/2	1"1/4
800	794	139	970	750	2188	2220	2400	113	433	478	568	658	718	898	//	1638	1793	Øi300/Øe380	1"1/4	1"1/2	1"1/4
1000	1042	181	1070	850	2242	2270	2490	101	454	499	589	679	739	989	//	1660	1814	Øi300/Øe380	1"1/2	2"	1"1/2
1500	1445	224	1210	950	2440	2495	2730	109	440	585	675	765	825	1075	//	1895	2050	Øi300/Øe380	1"1/2	2"	1"
2000	1978	279	1360	1100	2492	2570	2850	91	467	587	692	797	867	842	1952	1877	2057	Øi350/Øe430	2"	2"	1"
2500	2315	328	1350	1250	2311	2480	2690	140	551	671	776	881	951	976	1816	1732	1891	Øi350/Øe430	2"	2"	1"
3000	2921	384	1350	1250	2811	2950	3130	140	551	731	836	941	1011	1036	2316	2232	2391	Øi350/Øe430	2"	2"	1"
4000	3769	521	1500	1400	2875	3050	3250	114	570	750	855	960	1030	1035	2315	2238	2410	Øi350/Øe430	2"	2"	1"
5000	4982	657	1700	1600	2915	3130	3380	94	580	750	855	960	1030	1035	2335	2265	2420	Øi350/Øe430	2"	2"	1"

EXTRA 1 WX

HEAT EXCHANGERS TECHNICAL DATA



Cordivari heat exchangers, with tubes bent to the bottom, are able to heat the complete volume in an homogeneous way.

Energy storing is therefore improved and ignition time data refer to the complete volume of the tank, while in traditional straight heat exchangers equipped calorifires, a range between 9-17% of the volume remains cold.

Model	Primary Flow rate [m³/h]	Ignition time (minutes) from 10 °C to t2 and primary at T1				Maximum power exchange (kW) with primary at T1, secondary within 10-45 °C and constant use of DHW production				DHW continuous production lt/h within 10-45 °C and primary at T1			
		T1/t2				T1				T1			
		55/50	65/60	70/60	80/60	55	65	70	80	55	65	70	80
200	2	113	113	77	49	7,3	11,5	13,7	18	178	283	338	455
	1	147	148	102	65	5,8	8,9	10,5	13,9	141	218	258	344
300	3	112	113	76	48	11,1	17	21	28	274	435	520	701
	1,5	145	146	102	65	8,9	13,8	16,3	21,6	219	339	402	534
500	4	139	140	96	60	15	23,8	28,5	38	369	587	702	947
	2	180	181	125	80	12,1	18,7	22,1	29,4	297	460	545	725
800	6	146	147	101	64	23	36	44	59	570	908	1087	1465
	3	186	188	130	83	18	29	34	46	465	721	854	1136
1000	10	128	128	86	54	33	53	63	86	814	1309	1571	2127
	5	157	157	107,9	69	27	43	51	69	687	1077	1281	1711
1500	15	120	119	82	51	51	81	98	133	1256	2022	2428	3290
	7,5	145	146	100	64	44	68	81	108	1075	1687	2008	2684
2000	20	121	122	83	52	69	111	133	180	1699	2738	3288	4453
	10	146	147	101	65	59	93	111	148	1465	2302	2741	3665
2500	20	118	119	81	51	84	134	160	216	2066	3309	3964	5352
	10	145	146	101	65	71	111	131	174	1755	2734	3244	4314
3000	20	128	127	87	55	100	159	190	255	2461	3926	4694	6321
	10	456	457	110	70	84	130	154	204	2082	3224	3817	5053
4000	20	126	127	87	56	131	207	247	330	3236	5121	6105	8168
	10	159	161	112	73	110	168	198	260	2718	4151	4903	6443
5000	20	137	138	96	61	162	253	301	401	3992	6270	7450	9921
	10	176	179	125	82	135	204	239	312	3332	5049	5923	7727

LOWER
HEAT EXCHANGER

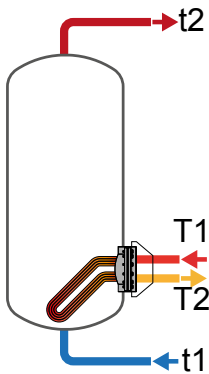

Model	Primary Flow rate [m³/h]	DHW produced in the first 10 minutes in lt/10' input 10 °C output 45 °C, storage at t2 and primary at T1				DHW produced in the first hour in lt/60' input 10 °C output 45 °C, storage at t2 and primary at T1				Heat exchanger pressure drop	
		T1/t2				T1/t2				[mm.c.a.]	[mbar]
		55/50	65/60	70/60	80/60	55/50	65/60	70/60	80/60		
200	2	247	319	328	347	360	498	542	635	309	30,3
	1	241	308	314	329	330	446	478	547	84,74	8,3
300	3	371	480	494	524	545	755	823	968	372	36,5
	1,5	362	464	474	496	501	678	729	834	101,02	9,9
500	4	616	791	810	851	849	1162	1254	1450	419	41,1
	2	604	770	784	814	792	1061	1129	1273	113,381	11,1
800	6	998	1280	1310	1373	1359	1855	1998	2301	718	70,4
	3	980	1249	1271	1318	1275	1705	1812	2037	189,22	18,6
1000	10	1273	1640	1683	1776	1788	2469	2678	3123	1380	135,3
	5	1252	1601	1635	1707	1687	2283	2446	2790	358,5	35,2
1500	15	1855	2394	2462	2605	2651	3675	4000	4689	2295	225,1
	7,5	1825	2338	2392	2504	2506	3407	3664	4204	589,6	57,8
2000	20	2546	3285	3377	3571	3622	5019	5459	6391	2996	293,8
	10	2507	3212	3285	3439	3435	4670	5021	5761	766,42	75,2
2500	20	2988	3856	3965	4196	4296	5951	6475	7586	2436	238,9
	10	2936	3760	3845	4023	4047	5491	5899	6755	624	61,2
3000	20	3748	4827	4955	5226	5307	7314	7928	9230	2836	278,1
	10	3685	4710	4809	5015	5004	6752	7226	8215	723	70,9
4000	20	4842	6232	6396	6740	6892	9475	10263	11913	3896	382,1
	10	4756	6070	6196	6452	6477	8699	9301	10533	989	97,0
5000	20	6362	8166	8363	8775	8891	12137	13081	15058	4707	461,6
	10	6252	7963	8109	8409	8363	11161	11860	13303	1192	116,9

MAXIMUM STORAGE EXPLOITATION WITH CURVED ANTILEGIONELLA® HEAT EXCHANGER



Model	Heated volume: Standard heat exchanger	Storage volume: Heat exchanger for 100% heated volume	Advantage in exploited volume	Advantage in percentage
	[lt]	[lt]	[lt]	[%]
200	165	190	25	13%
300	251	285	34	12%
500	438	485	47	10%
800	694	790	96	12%
1000	907	995	88	9%

Model	Heated volume: Standard heat exchanger	Storage volume: Heat exchanger for 100% heated volume	Advantage in exploited volume	Advantage in percentage
	[lt]	[lt]	[lt]	[%]
1500	1224	1445	221	15%
2000	1684	1978	294	15%
2500	1905	2315	410	18%
3000	2438	2921	483	17%
4000	3113	3769	656	17%
5000	4116	4982	866	17%

EXTRA 1 WX

HEAT EXCHANGERS PRESSURE DROP

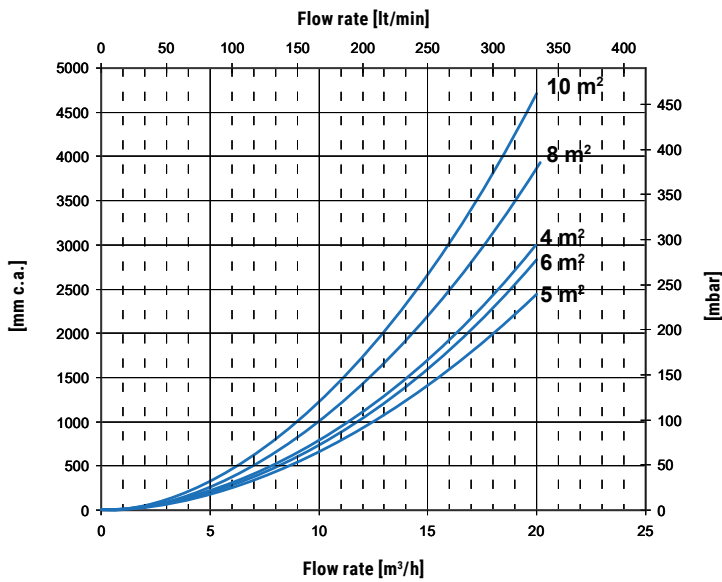
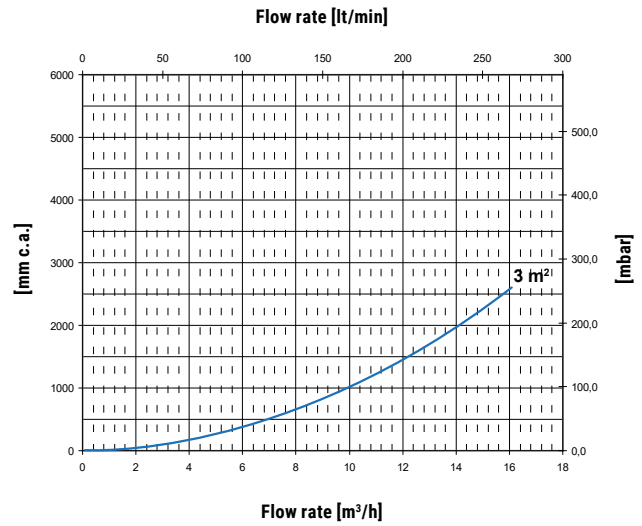
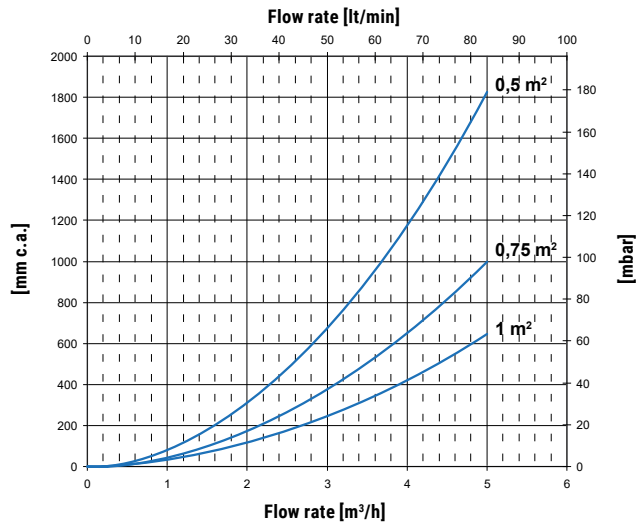

EXAMPLE OF INSTALLATION WITH EXTRA 1

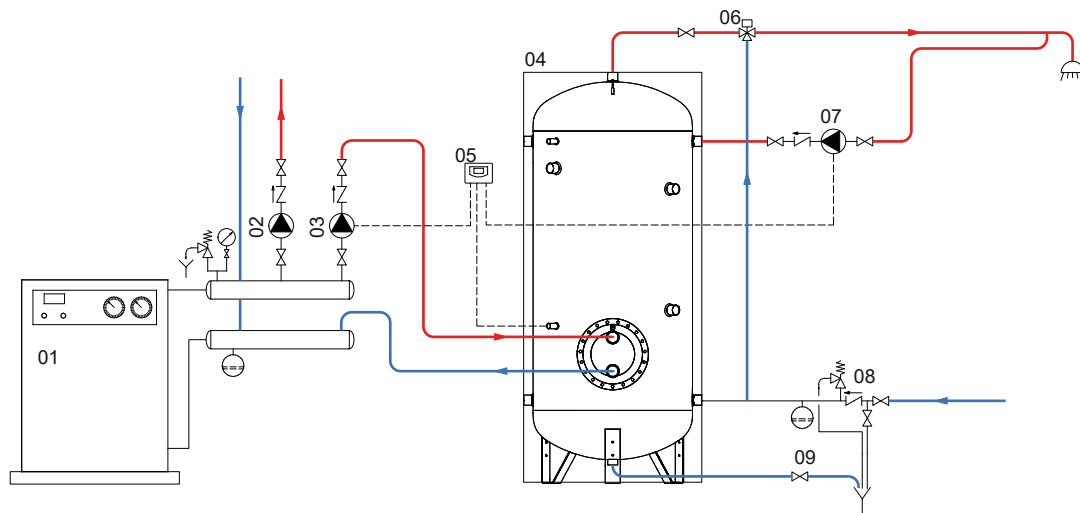

1	Generator	4	EXTRA 1	7	D.H.W. recirculation group
2	Heating system circulation group	5	Electronic control /thermostat	8	Hydraulic safety group
3	D.H.W. circulation group	6	Thermostatic mixing valve	9	Blowdown valve

The following schemes are purely illustrative. To realize the installation, always refer to a qualified technician.

EXTRA 1-2-3 WXC-XXC / EXTRA 1 COMPACT

HEAT EXCHANGERS TECHNICAL DATA

Heat Exchanger output referred to temperature and flow rate of primary circuit and with secondary at 10/45°C at maximum withdrawal of producible DHW (Upper limit of the curves referred to maximum primary flow rate in the heat exchanger, while the lower limit in the curves refer to the minimum primary flow rate)

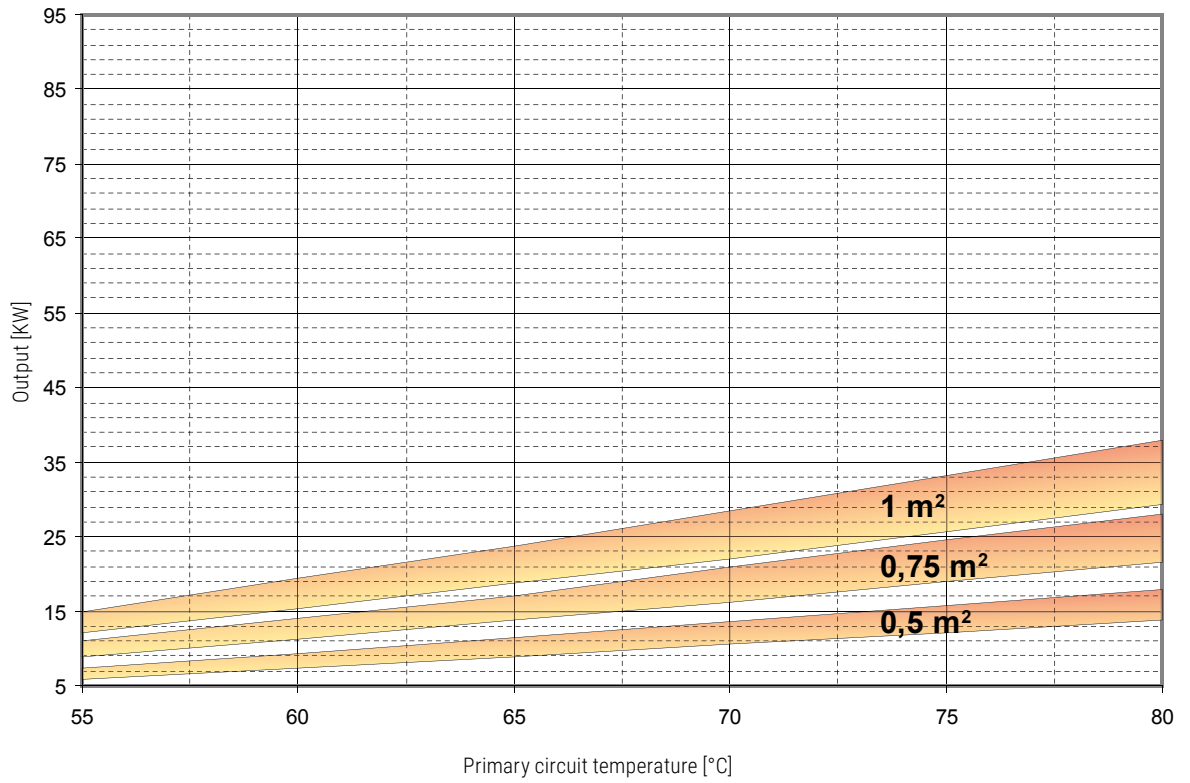

Extractable heat exchanger surface	0,5 m ²		0,75 m ²		1 m ²	
	MAX	MIN	MAX	MIN	MAX	MIN
Flow rate [m ³ /h]	2	1	3	1,5	4	2

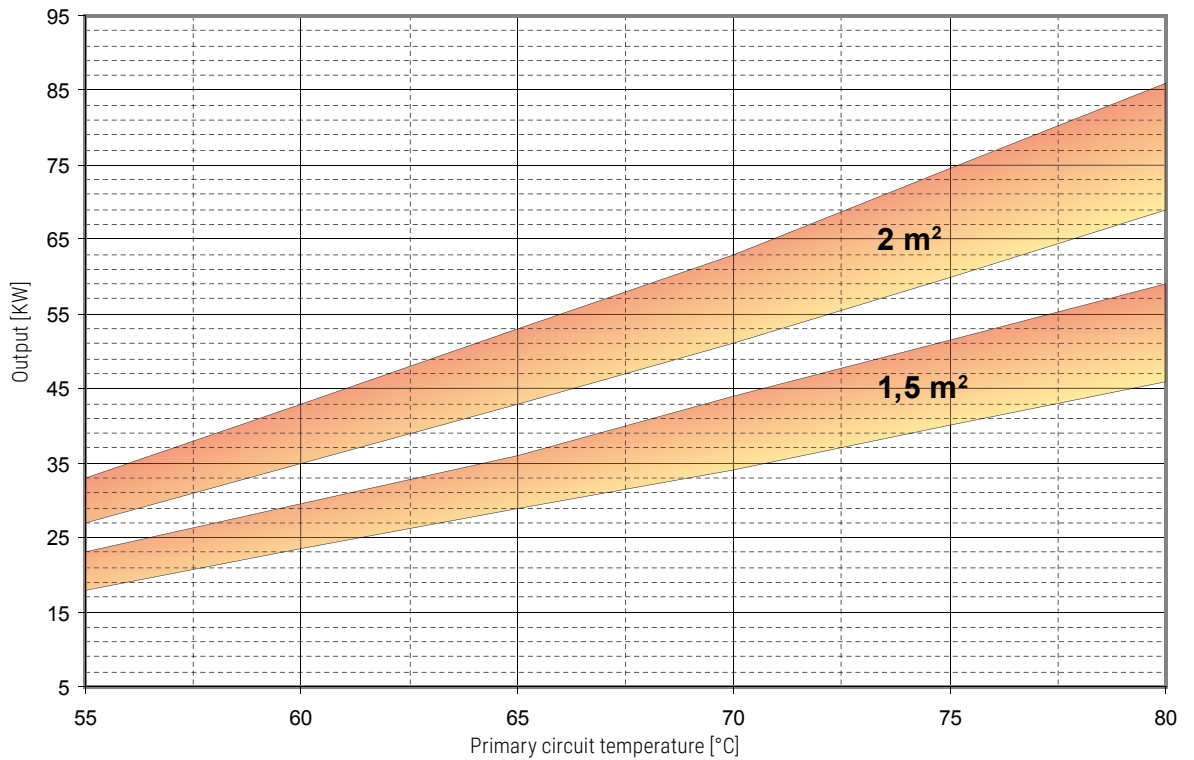

Extractable heat exchanger surface	1,5 m ²		2 m ²	
	MAX	MIN	MAX	MIN
Flow rate [m ³ /h]	6	3	10	5

EXTRA 1-2-3 WXC-XXC / EXTRA 1 COMPACT

HEAT EXCHANGERS TECHNICAL DATA

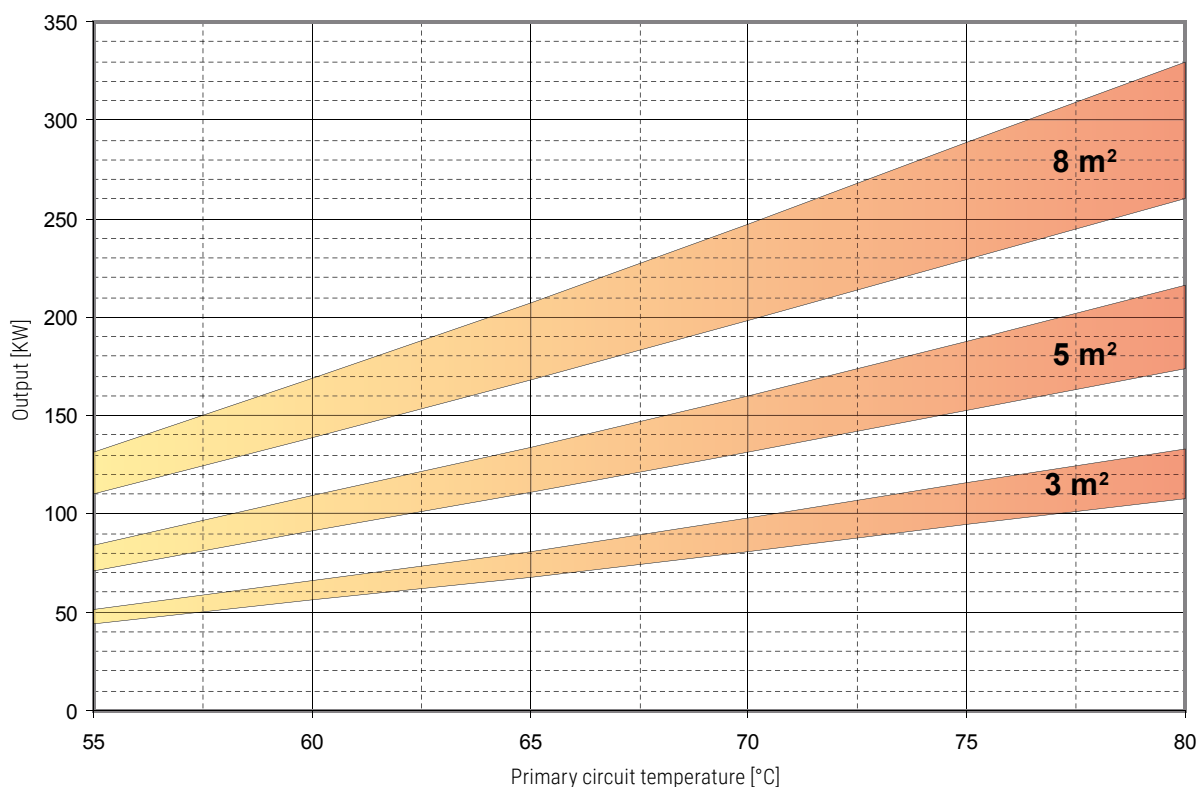

Extractable heat exchanger surface	3 m ²		5 m ²		8 m ²	
	MAX	MIN	MAX	MIN	MAX	MIN
Flow rate [m ³ /h]	15	7,5	20	10	20	10

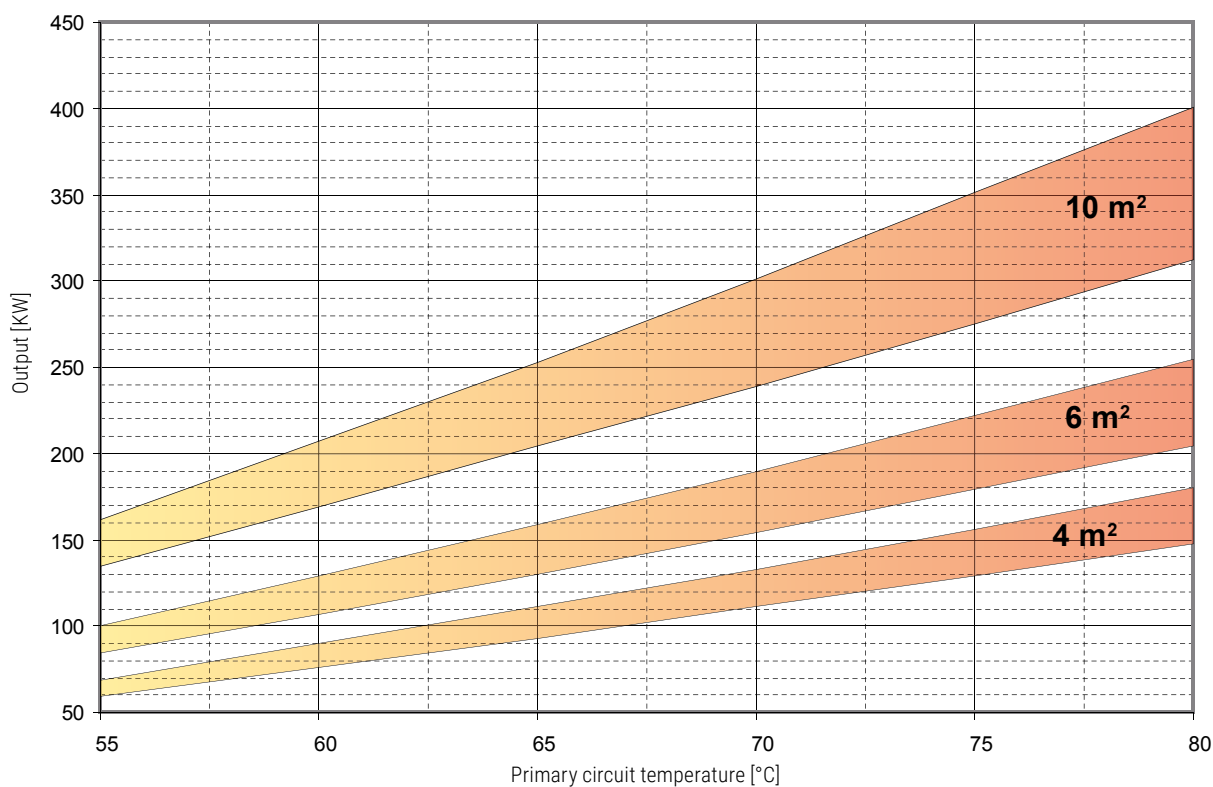

Extractable heat exchanger surface	4 m ²		6 m ²		10 m ²	
	MAX	MIN	MAX	MIN	MAX	MIN
Flow rate [m ³ /h]	20	10	20	10	20	10